



TASK 30

STANDARDS/ GUIDELINES



WAYFINDING SIGNAGE MASTER PLAN

VOLUME 30 TRANSPORTATION MALLS

PROJECT N° FC5801 - C / #7

 **Hartsfield-Jackson**
Atlanta International Airport.

Prepared by:  **AIS** |  **VALANCOURT**
INTERNATIONAL, LLC

1.0

GRAPHIC STANDARDS

VOLUME **30** TRANSPORTATION MALLS

- 11 Typography
- 12 Terminology/Symbology
- 13 Message Hierarchy
- 14 Foreign Language
- 15 Arrow Standards
- 16 Color Standards

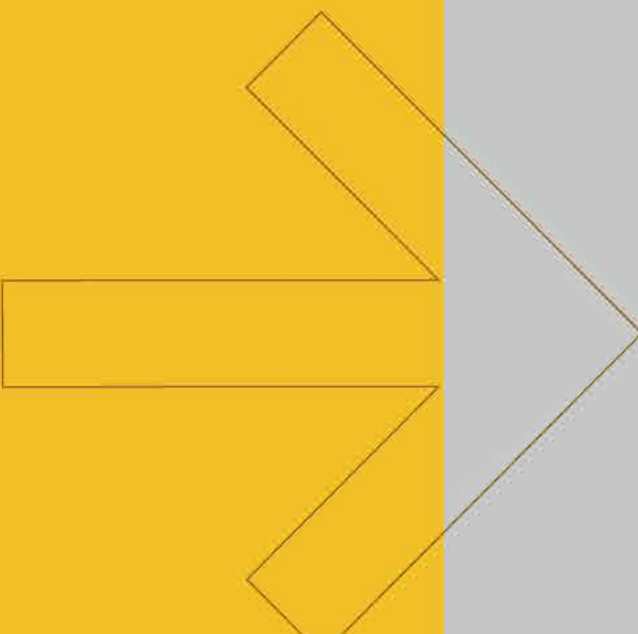

1.0 GRAPHIC STANDARDS

- 1.1 Typography 1-01
 - Line Spacing 1-02
- 1.2 Terminology / Symbology
 - Principal Facilities 1-03
 - Fundamental Functions 1-04
 - Building Circulation 1-05
 - Dynamic Message Terminology 1-06
 - Specialty Icons - Primary Identification 1-07
- 1.3 Message Hierarchy
 - Message Function 1-08
 - Message Hierarchy Example 1-09
- 1.4 Foreign Language
 - Foreign Language 1-10
 - Multi Lingual Text Translations 1-11
- 1.5 Arrow Standards 1-12
- 1.6 Color Standards
 - Color Specifications 1-13
 - Color Application – Primary Directional – Overhead 1-14

#	REVISION	DATE
1	Updated	05/06/16
2	Updated	09/19/17

ABCDEFGHIJKLMNOPQRSTUVWXYZ
 abcdefghijklmnopqrstuvwxyz
 0123456789@#%^&*()::

Gotham Book

.75X

x Domestic Terminal

X = Letter Cap. Height

Letter Spacing Correct - Kerning at "- 33 points"

Domestic Terminal

Letter Spacing Too Wide

Domestic Terminal

Letter Spacing Too Close

#	REVISION	DATE
1	Updated	05/06/16
2	Updated	09/19/17

Line Spacing

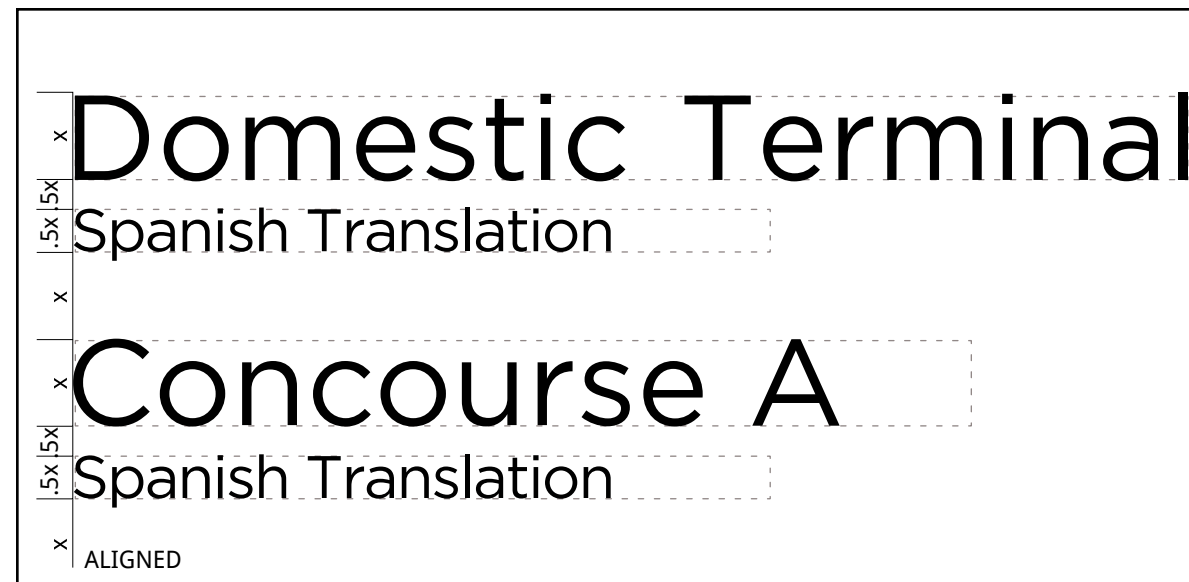

Line Spacing Examples



Spacing Example between arrow, symbol and messages

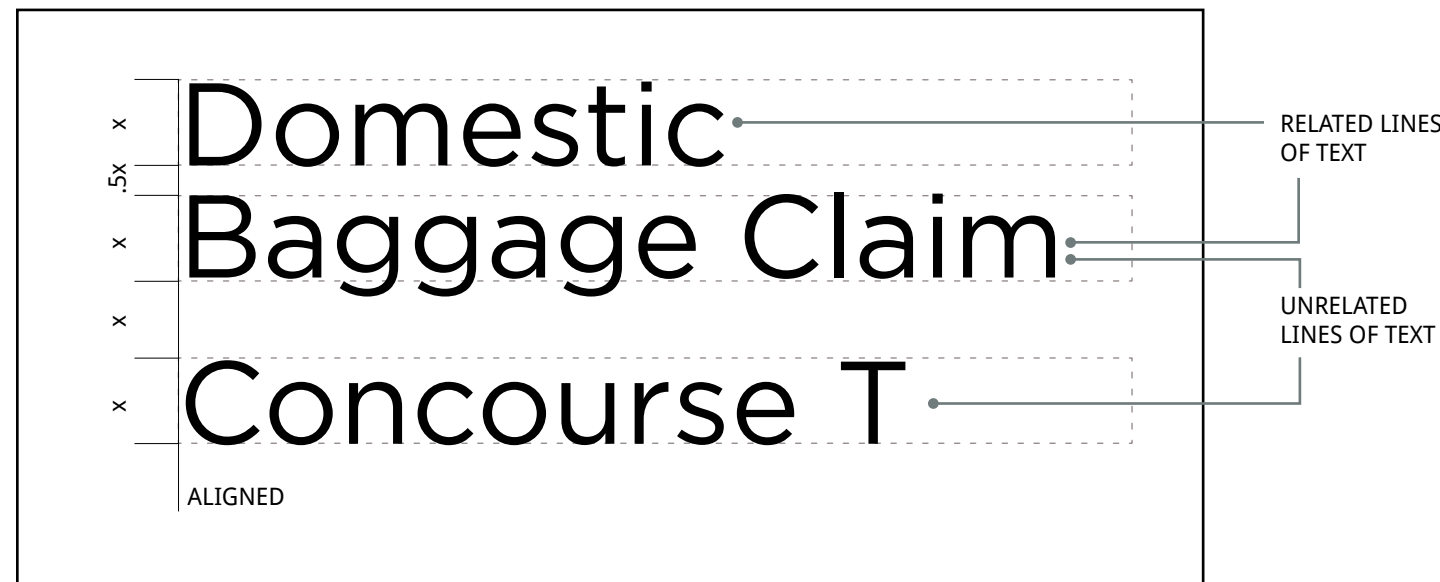

Unrelated Line Spacing Examples

Principal Facilities

#	REVISION	DATE
1	Updated	05/06/16
2	Updated	09/19/17

TERMINOLOGY

SYMBOL

INTERIOR APPLICATIONS

Domestic Terminal



- Is always used in conjunction with the Transportation Mall
- Identifies Domestic Terminal

International Terminal



- Is always used in conjunction with the Transportation Mall
- Identifies International Terminal

Concourse T



- Is always used in conjunction with the Transportation Mall
- Identifies Concourse T

Concourse A



- Is always used in conjunction with the Transportation Mall
- Identifies Concourse A

Concourse B



- Is always used in conjunction with the Transportation Mall
- Identifies Concourse B

Concourse C



- Is always used in conjunction with the Transportation Mall
- Identifies Concourse C

Concourse D



- Is always used in conjunction with the Transportation Mall
- Identifies Concourse D

Concourse E



- Is always used in conjunction with the Transportation Mall
- Identifies Concourse E

Concourse F



- Is always used in conjunction with the Transportation Mall
- Identifies Concourse F

Fundamental Functions

#	REVISION	DATE
1	Updated	05/06/16
2	Updated	09/19/17

TERMINOLOGY

SYMBOL

INTERIOR APPLICATIONS

Domestic Baggage Claim



· Is always used in conjunction with the Transportation Mall

International Baggage Claim



· Is always used in conjunction with the Transportation Mall

Ground Transportation



· Is always used in conjunction with the Transportation Mall

Gates



· Is always used in conjunction with the Transportation Mall

Building Circulation

#	REVISION	DATE
1	Updated	05/06/16
2	Updated	09/19/17

TERMINOLOGY

SYMBOL

INTERIOR APPLICATIONS

Elevator

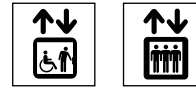

· Identifies elevators

Elevator to:

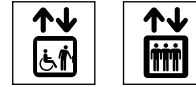

· Identifies elevators

Escalator



· Identifies escalators

Escalator to:



· Identifies escalators

Train to:

· Identifies trains

Stairs



· Identifies stairs

Emergency Stairs



· Identifies emergency stairs



Dynamic Message Terminology

#	REVISION	DATE
1	Updated	05/06/16
2	Updated	09/19/17

TERMINOLOGY

Concourses T, A, B, C, D, E, F

Domestic Baggage Claim

International Baggage Claim

Ground Transportation

Train to:

Train/Walk to:

Escalator to:

Elevator to:

Note:
Dynamic messages shown are samples only.
Owner will review / confirm all messages.

Specialty Icons - Primary Identification

#	REVISION	DATE
1	Updated	05/06/16
2	Updated	09/19/17

TERMINOLOGY

SYMBOL

INTERIOR APPLICATIONS

Concourse T



· Identifies Concourse T

Concourse A



· Identifies Concourse A

Concourse B



· Identifies Concourse B

Concourse C



· Identifies Concourse C

Concourse D



· Identifies Concourse D

Concourse E



· Identifies Concourse E

Concourse F



· Identifies Concourse F



Message Function

#	REVISION	DATE
1	Updated	05/06/16
2	Updated	09/19/17

	PRIMARY	SECONDARY	TERTIARY
Directional	Domestic Terminal International Terminal Concourse T Concourse A Concourse B Concourse C Concourse D Concourse E Concourse F	Baggage Claim Ground Transportation Gates	Train to: Elevator to: Walk to:
Identification	Concourse T Concourse A Concourse B Concourse C Concourse D Concourse E Concourse F	Elevators	
Information or Orientation	<i>(Airport Directory)</i> <i>(MUFIDS)</i>	<i>(Visual Paging)</i> <i>(Supplemental Languages)</i>	
Regulatory or Safety	Exit Emergency Exit Only No Smoking Authorized Personal Only Do Not Enter Be Careful. Watch Your Step. <i>(All FAA notices and required signs)</i>		

1.0 GRAPHIC STANDARDS

#	REVISION	DATE
1	Updated	05/06/16
2	Updated	09/19/17

1.3 Message Hierarchy

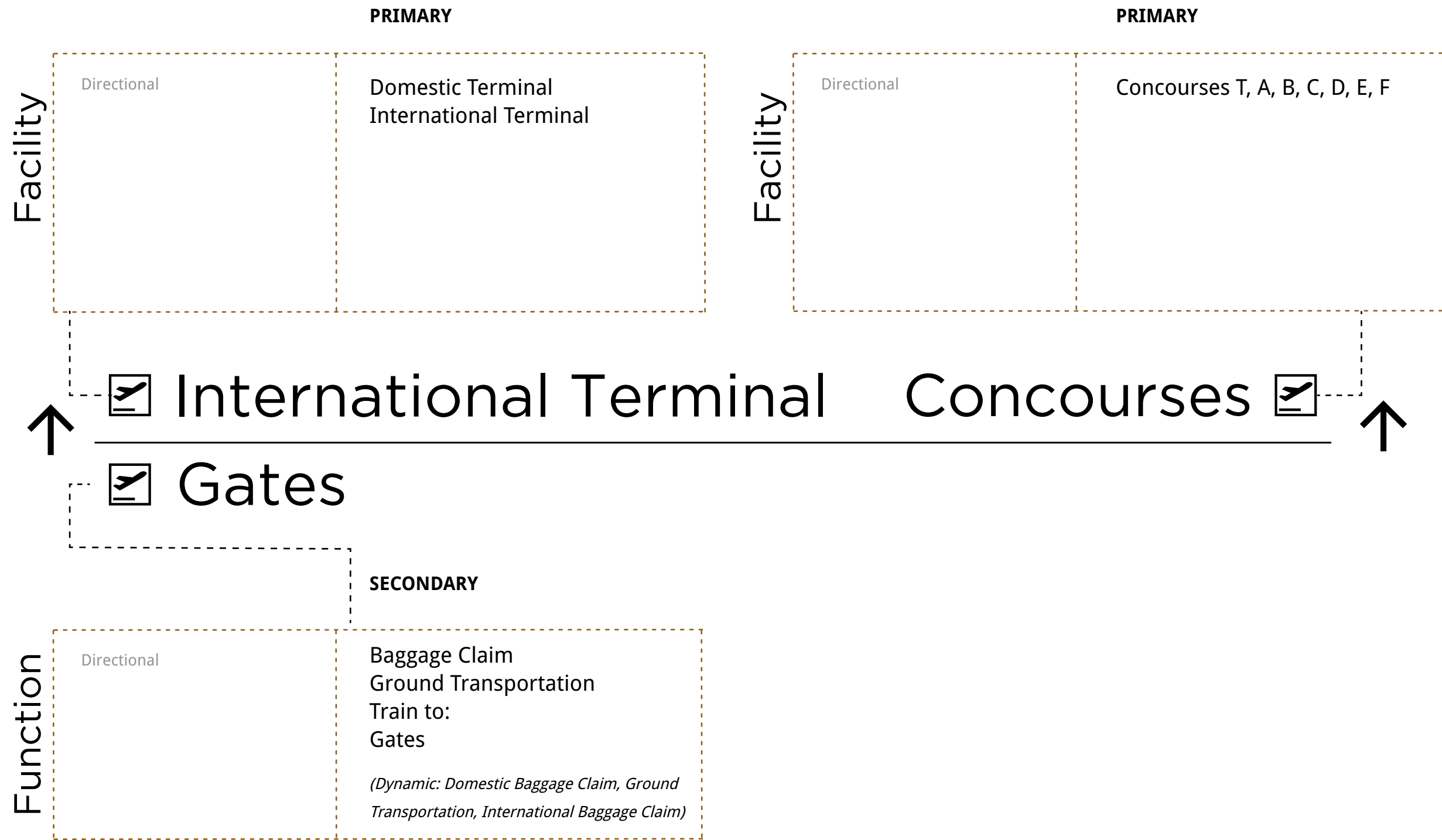

Note:
Terminal-Directional Primary Message Hierarchy Example

- Correct Terminology:
 - Terminal North
 - Terminal South
 - Domestic Terminal
 - International Terminal
- Incorrect Terminology: ~~Domestic Terminal North~~

SCALE: NTS

#	REVISION	DATE
1	Updated	05/06/16
2	Updated	09/19/17



Primary Foreign Language Translation Application
Overhead Directional Signs
SCALE: NTS

Multi-Lingual Text Translation

Principal Facilities

ENGLISH	TRANSLATION
Domestic Terminal	Terminal Nacional
International Terminal	Terminal Internacional
Concourse T	Terminal T
Concourse A	Terminal A
Concourse B	Terminal B
Concourse C	Terminal C
Concourse D	Terminal D
Concourse E	Terminal E
Concourse F	Terminal F

Fundamental Functions

ENGLISH	TRANSLATION
Domestic Baggage Claim	Reclamo de Equipaje Nacional
International Baggage Claim	Reclamo de Equipaje Internacional
Ground Transportation	Transporte Terrestre
Gates	Puertas de Embarque

Multi-Lingual Text Translation

Building Circulation

#	REVISION	DATE
1	Updated	05/06/16
2	Updated	09/19/17

ENGLISH	TRANSLATION
Elevator	Ascensor
Elevator to:	Ascensor a:
Escalator	Escalera Eléctrica
Escalator to:	Escalera Eléctrica a:
Train to:	Tren a:
Stairs	Escalera
Emergency Stairs	N/A

1.0 GRAPHIC STANDARDS

#	REVISION	DATE
1	Updated	05/06/16
2	Updated	09/19/17

1.5 Arrow Standards

These figures define the arrow orientations and size that shall be used throughout the Transportation Malls.

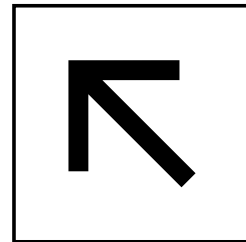

Up to the Left
10 o'clock

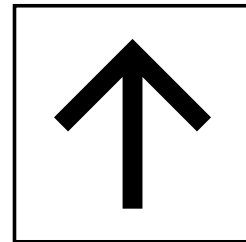

Up and/or Straight
Ahead / 12 o'clock

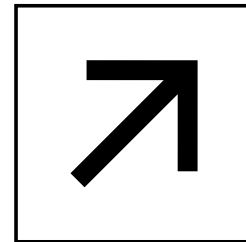

Up to the Right
2 o'clock

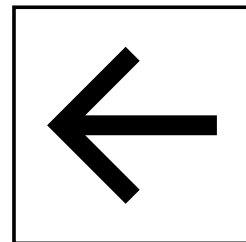

To the left
9 o'clock

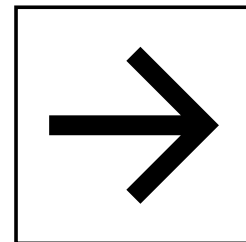
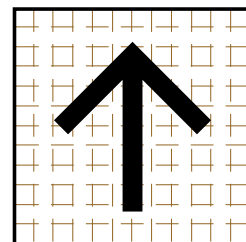

To the Right
3 o'clock

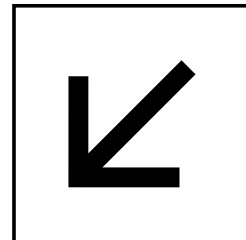

Down to the Left
7 o'clock

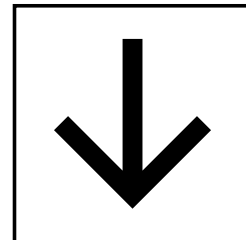

Down
6 o'clock

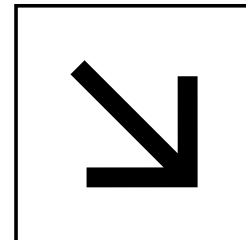

Down to the Right
5 o'clock

Arrows Orientation
SCALE: NTS

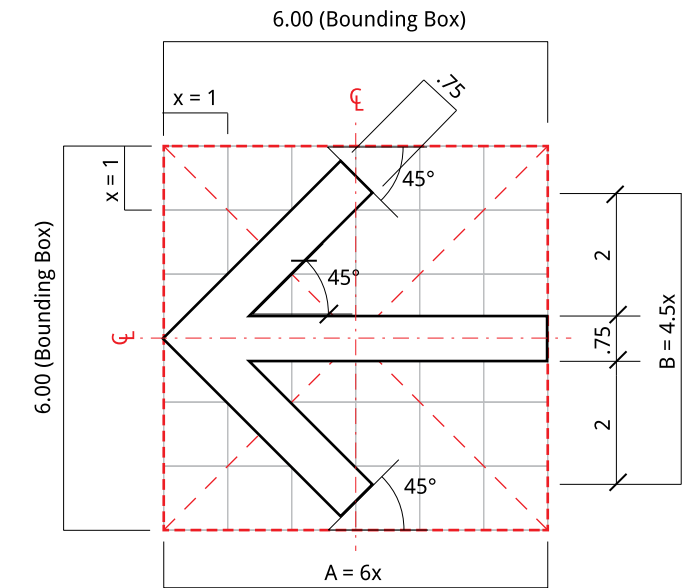

Straight Arrow:
Use for arrows angled at: 0°, 90°, 180°, 270°

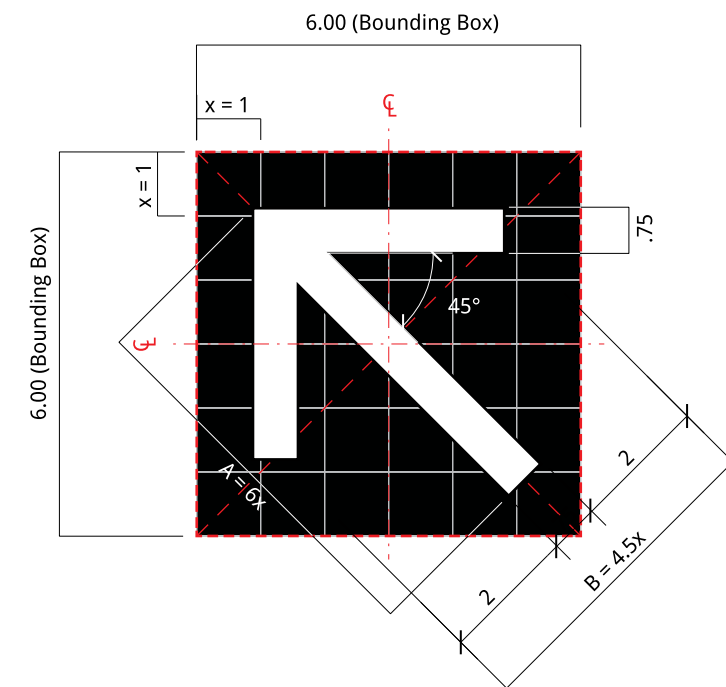

Angled Arrow:
Use for arrows angled at: 45°, 135°, 225°, 315°





Arrows Sizes
SCALE: NTS

Color Specifications

#	REVISION	DATE
1	Updated	05/06/16
2	Updated	09/19/17

This section of the document shall specify colors and applications that are to be used in the Transportation Malls

**or approved equal*

COLOR APPLICATION	COLOR	PANTONE Equivalent	MATERIAL Equivalent
Concourse Identification	N/A	N/A	 Satin Brushed Aluminum
Sign Panel	N/A	N/A	 Satin Brushed Aluminum
Accent Panel			
- Concourse T	White	N/A	Sign Grade Translucent Polycarbonate
- Concourse A	White	N/A	Sign Grade Translucent Polycarbonate
- Concourse B	White	N/A	Sign Grade Translucent Polycarbonate
- Concourse C	White	N/A	Sign Grade Translucent Polycarbonate
- Concourse D	White	N/A	Sign Grade Translucent Polycarbonate
- Concourse E	Yellow	 Pantone 123	Sign Grade Translucent Polycarbonate
- Concourse F	Yellow	 Pantone 123	Sign Grade Translucent Polycarbonate
Arrow	White	N/A	Sign Grade Translucent Polycarbonate
Symbol	White	N/A	Sign Grade Translucent Polycarbonate
Background	Black	 Process Black	Sign Grade Translucent Polycarbonate
English Text	White	N/A	Sign Grade Translucent Polycarbonate
Translation Text	White	N/A	Sign Grade Translucent Polycarbonate







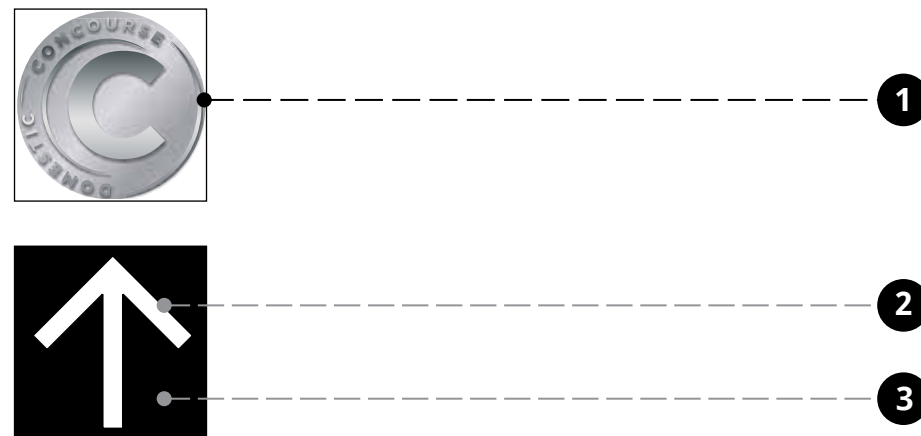

Color Applications - Primary Directional - Overhead

#	REVISION	DATE
1	Updated	05/06/16
2	Updated	09/19/17

Sign Finishes



Sign Color Application

COLOR APPLICATION	COLOR
1 Concourses Identifications	Dimensional letters on Satin Brushed Aluminum Background
2 Arrow	 White
3 Arrow panel	 Black
4 Symbol	 White
5 Background	 Black
6 English Text	 White
7 Translation Text	 White
8 Accent Bar	 White (Domestic) /  Pantone 123 (International)

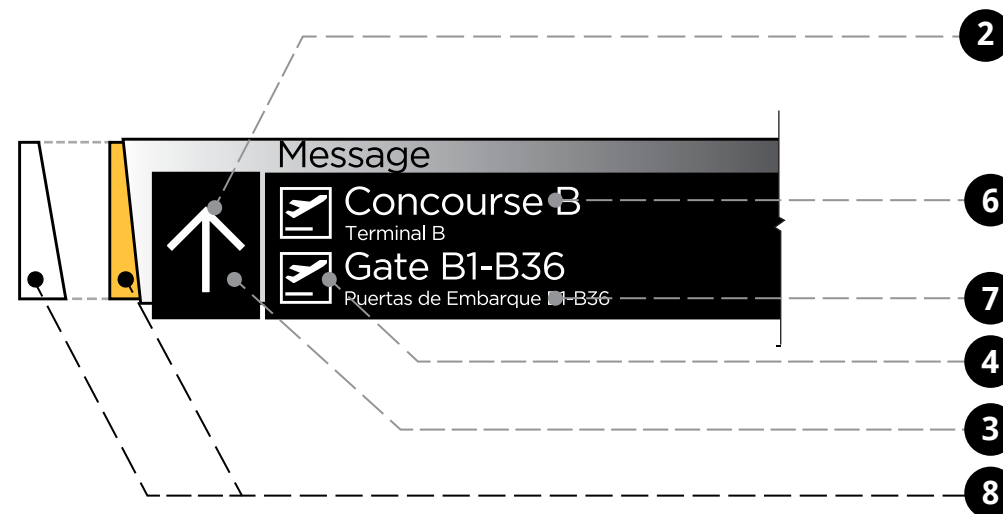

Color Application Examples
SCALE: NTS

2.0

SIGN TYPES TRANSPORTATION MALLS

VOLUME **30** TRANSPORTATION MALLS

- 2.1 Sign Type Series Number
- 2.2 Sign Type Identification System
- 2.3 Sign Type Index
- 2.4 Sign Type Layouts

2.0 SIGN TYPES

2.1 Sign Type Series Number 2-01

2.2 Sign Type Identification System..... 2-02

2.3 Sign Type Index 2-03

2.4 Sign Type Layouts

 ST-302 - Primary Directional - Ceiling Suspended (Dynamic) 2-07

 ST-304 - Primary Directional - Soffit Mounted 2-08

 ST-306 - Primary Directional - Soffit Mounted (Dynamic) 2-09

 ST-312 - Primary Directional - Ceiling Mounted 2-10

 ST-314 - Primary Directional - Wall/Soffit Mounted (Dynamic) 2-11

 ST-320 - Primary Directional - Soffit Mounted 2-12

 ST-322 - Primary Directional - Wall/Soffit Mounted (Dynamic) 2-13

 ST-328 - Secondary Directional - Soffit Mounted 2-14

 ST-342 - Primary Identification - Ceiling Mounted 2-15

 ST-344 - Primary Identification - Ceiling Mounted 2-16

 ST-350 - Secondary Identification - Flag Mounted 2-17

 ST-352 - Secondary Identification - Wall Mounted 2-18

 ST-360 - Primary Informational - Wall Mounted 2-19

2.0 SIGN TYPES

#	REVISION	DATE
1	Updated	05/06/16
2	Updated	09/19/17

2.1 Sign Type Series Number

- **100 Series** – Terminals (Domestic / International)
 - 100 - 129 – Primary Directional
 - 130 - 139 – Secondary Directional
 - 140 - 149 – Primary Identification
 - 150 - 159 – Secondary Identification
 - 160 - 169 – Primary Informational
 - 170 - 179 – Secondary Informational

- **200 Series** – Concourses
 - 200 - 229 – Primary Directional
 - 230 - 239 – Secondary Directional
 - 240 - 249 – Primary Identification
 - 250 - 259 – Secondary Identification
 - 260 - 269 – Primary Informational
 - 270 - 279 – Secondary Informational

- **300 Series** – Transportation Mall
 - 300 - 329 – Primary Directional
 - 330 - 339 – Secondary Directional
 - 340 - 349 – Primary Identification
 - 350 - 359 – Secondary Identification
 - 360 - 369 – Primary Informational
 - 370 - 379 – Secondary Informational

- **400 Series** – Curbsides (Domestic / International)
 - 400 - 429 – Primary Directional
 - 430 - 439 – Secondary Directional
 - 440 - 449 – Primary Identification
 - 450 - 459 – Secondary Identification
 - 460 - 469 – Primary Informational
 - 470 - 479 – Secondary Informational

- **500 Series** – Ground Transportation (Domestic / International)
 - 500 - 529 – Primary Directional
 - 530 - 539 – Secondary Directional
 - 540 - 549 – Primary Identification
 - 550 - 559 – Secondary Identification
 - 560 - 569 – Primary Informational
 - 570 - 579 – Secondary Informational

- **600 Series** – Parking (Domestic / International)
 - 600 - 629 – Primary Directional
 - 630 - 639 – Secondary Directional
 - 640 - 649 – Primary Identification
 - 650 - 659 – Secondary Identification
 - 660 - 669 – Primary Informational
 - 670 - 679 – Secondary Informational

- **700 Series** – Roadways (Domestic / International)
 - 700 - 729 – Primary Directional
 - 730 - 739 – Secondary Directional
 - 740 - 749 – Primary Identification
 - 750 - 759 – Secondary Identification
 - 760 - 769 – Primary Informational
 - 770 - 779 – Secondary Informational

Sign Location Indicator

#	REVISION	DATE
1	Updated	05/06/16
2	Updated	09/19/17

2.2 - 1 Sign Location Indicator

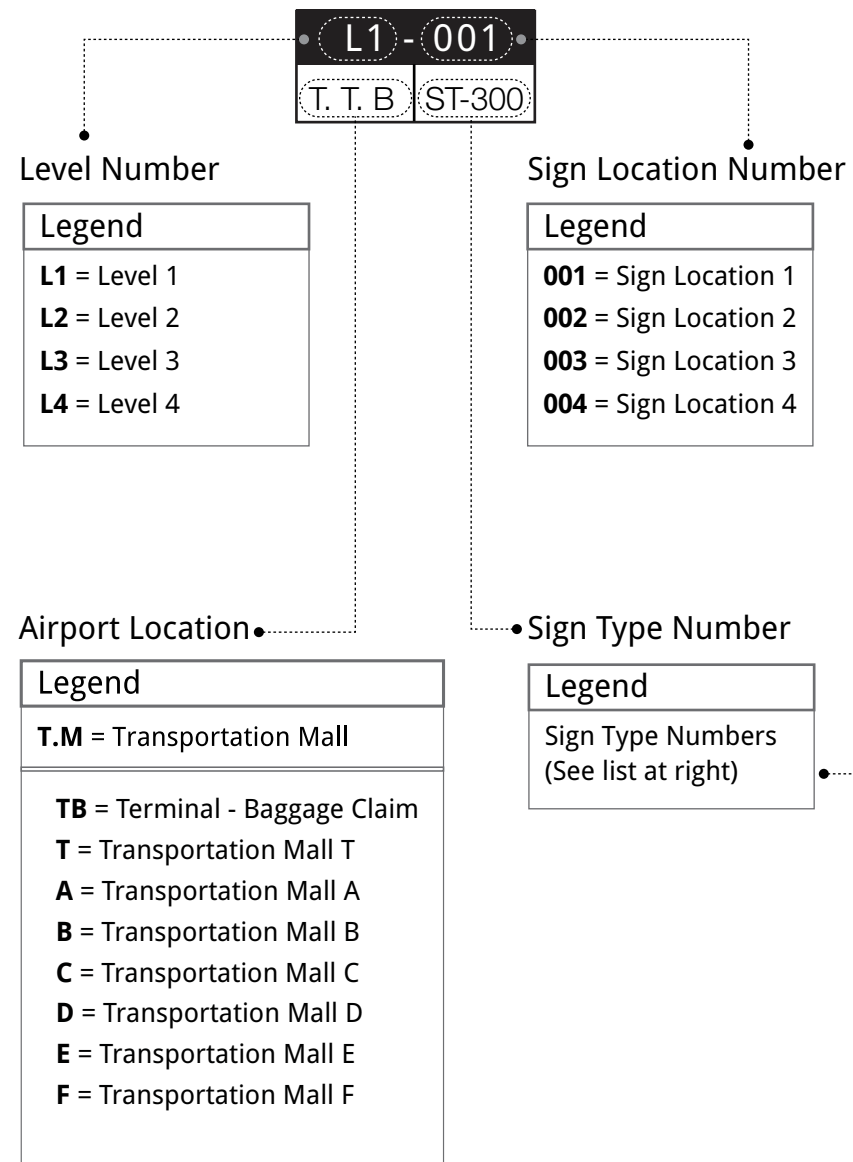









2.2 - 2 Sign Type Series Numbers

Sign Type 300 Series – Transportation Malls
ST. 300 - ST. 329 – Primary Directional
ST. 330 - ST. 339 – Secondary Directional
ST. 340 - ST. 349 – Primary Identification
ST. 350 - ST. 359 – Secondary Identification
ST. 360 - ST. 369 – Primary Informational
ST. 370 - ST. 379 – Secondary Informational

2.0 SIGN TYPES

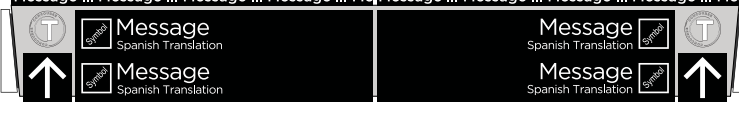
#	REVISION	DATE
1	Updated	05/06/16
2	Updated	09/19/17

2.3 Sign Type Index

ST-302 Primary Directional - Ceiling Suspended (Dynamic)		
<p>Domestic Concourses</p>  <p>- 2 Directionals / 3 Levels of Messaging / 2 Sided with Dynamic Display - Overall dimensions: 2' - 5-1/2" H x 15' - 4" W x 7" D - Provides directional information in multi directional areas - For use in Domestic Concourses only: Accent Color White</p>	N/A	<p>International Concourses</p>  <p>- 2 Directionals / 3 Levels of Messaging / 2 Sided with Dynamic Display - Overall dimensions: 2' - 5-1/2" H x 15' - 4" W x 7" D - Provides directional information in multi directional areas - For use in International Concourses only : Accent Color Yellow - Pantone 123</p>
ST-304 Primary Directional - Soffit Mounted		
<p>Domestic Concourses</p>  <p>- 2 Directionals / 3 Levels of Messaging / 1 Sided - Overall dimensions: 2' - 1-1/2" H x 15' - 4" W x 5" D - Provides primary directional information - For use in Domestic Concourses only: Accent Color White</p>	N/A	<p>International Concourses</p>  <p>- 2 Directionals / 3 Levels of Messaging / 1 Sided - Overall dimensions: 2' - 1-1/2" H x 15' - 4" W x 5" D - Provides primary directional information - For use in International Concourses only : Accent Color Yellow - Pantone 123</p>
ST-306 Primary Directional - Soffit Mounted (Dynamic)		
<p>Domestic Concourses</p>  <p>- 2 Directionals / 2 Levels of Messaging / 2 Sided with Dynamic Display Bar - Overall dimensions: 2'- 4" H x 15' - 5" W x 7" D - Provides directional information in multi directional areas - For use in Domestic Concourses only: Accent Color White</p>	N/A	<p>International Concourses</p>  <p>- 2 Directionals / 2 Levels of Messaging / 2 Sided with Dynamic Display Bar - Overall dimensions: 2'- 4" H x 15' - 5" W x 7" D - Provides directional information in multi directional areas - For use in International Concourses only : Accent Color Yellow - Pantone 123</p>
ST-312 Primary Directional - Soffit Mounted		
<p>Domestic Concourses</p>  <p>- 2 Directionals / 2 Levels of Messaging / 1 Sided - Overall dimensions: 1' - 8-1/2" H x 15' - 5" W x 5" D - Provides primary directional information - For use in Domestic Concourses only: Accent Color White</p>	N/A	<p>International Concourses</p>  <p>- 2 Directionals / 2 Levels of Messaging / 1 Sided - Overall dimensions: 1' - 8-1/2" H x 15' - 5" W x 5" D - Provides primary directional information - For use in International Concourses only : Accent Color Yellow - Pantone 123</p>

2.0 SIGN TYPES

#	REVISION	DATE
1	Updated	05/06/16
2	Updated	09/19/17





2.3 Sign Type Index

ST-314 Primary Directional - Soffit Mounted (Dynamic)		
Domestic Concourses	N/A	International Concourses
- 2 Directionals / 2 Levels of Messaging / 1 Sided with Dynamic Display - Overall dimensions: 1' - 10-1/2" H x 15' -5" W x 5" D - Provides primary directional information - For use in Domestic Concourses only: Accent Color White	N/A	- 2 Directionals / 2 Levels of Messaging / 1 Sided with Dynamic Display - Overall dimensions: 1' - 10-1/2" H x 15' -5" W x 5" D - Provides primary directional information - For use in International Concourses only: Accent Color Yellow - Pantone 123
ST-320 Primary Directional - Soffit Mounted		
Domestic Concourses	N/A	International Concourses
- 1 Directional / 3 Levels of Messaging / 1 Sided - Overall dimensions: 2' - 4" H x 7' - 11" W x 5" D - Provides primary directional information in multi directional areas - For use in Domestic Concourses only: Accent Color White	N/A	- 1 Directional / 3 Levels of Messaging / 1 Sided - Overall dimensions: 2' - 4" H x 7' - 11" W x 5" D - Provides primary directional information in multi directional areas - For use in International Concourses only: Accent Color Yellow - Pantone 123
ST-322 Primary Directional - Soffit / Wall Mounted (Dynamic)		
Domestic Concourses	N/A	International Concourses
- 1 Directional / 3 Levels of Messaging / 1 Sided with Dynamic Display - Overall dimensions: 2' - 4-1/4" H x 7' - 11" W x 5" D - Provides primary directional information in multi directional areas - For use in Domestic Concourses only: Accent Color White	N/A	- 1 Directional / 3 Levels of Messaging / 1 Sided with Dynamic Display - Overall dimensions: 2' - 4-1/4" H x 7' - 11" W x 5" D - Provides primary directional information in multi directional areas - For use in International Concourses only: Accent Color Yellow - Pantone 123
ST-328 Secondary Directional - Soffit / Wall Mounted		
Domestic Concourses	N/A	International Concourses
- 1 Directional / 2 Levels of Messaging / 1 Sided - Overall dimensions: 1' - 8-1/2" H x 7' - 11" W x 5" D - Provides secondary directional information - For use in Domestic Concourses only: Accent Color White	N/A	- 1 Directional / 2 Levels of Messaging / 1 Sided - Overall dimensions: 1' - 8-1/2" H x 7' - 11" W x 5" D - Provides secondary directional information - For use in International Concourses only: Accent Color Yellow - Pantone 123

2.0 SIGN TYPES

#	REVISION	DATE
1	Updated	05/06/16
2	Updated	09/19/17

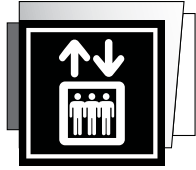
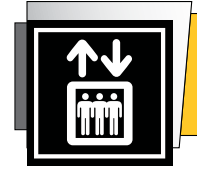

2.3 Sign Type Index

ST-342 Primary Identification - Soffit Mounted		
Domestic Concourses	N/A	N/A
 <p>CONCOURSE A Spanish Translation Message ... Message ... Me ↑</p>		
<ul style="list-style-type: none"> - Overall dimensions: 2' - 0" H x 8' - 0" W x 2' - 6" D - 2 Sided with Dynamic Display - Provides Gates and Concourse information - For use in Domestic Concourses only: Accent Color White 	N/A	N/A
ST-344 Primary Identification - Soffit Mounted		
N/A	N/A	International Concourses
		 <p>CONCOURSE F Spanish Translation Message ... Message ... Me ↑</p>
N/A	N/A	<ul style="list-style-type: none"> - Overall dimensions: 2' - 0" H x 8' - 0" W x 2' - 6" D - 2 Sided with Dynamic Display - Provides Gates and Concourse information - For use in International Concourses only : Accent Color Yellow - Pantone 123
ST-350 Secondary Identification - Flag Mounted		
Domestic Concourses	N/A	International Concourses
		
<ul style="list-style-type: none"> - Overall dimensions: 1' - 1-1/2" H x 1' - 3-1/2" W x 5" D - Provides Elevator information - For use in Domestic Concourses only: Accent Color White 	N/A	<ul style="list-style-type: none"> - Overall dimensions: 1' - 1-1/2" H x 1' - 3-1/2" W x 5" D - Provides Elevator information - For use in International Concourses only : Accent Color Yellow - Pantone 123
ST-352 Secondary Identification - Wall Mounted		
Domestic Concourses	N/A	International Concourses
 <p>Elevator Spanish Trans.</p>		 <p>Elevator Spanish Trans.</p>
<ul style="list-style-type: none"> - Overall dimensions: 9" H x 2' - 5-1/2" W x 1" D - Provides Elevator information - For use in Domestic Concourses only: Accent Color White 	N/A	<ul style="list-style-type: none"> - Overall dimensions: 9" H x 2' - 5-1/2" W x 1" D - Provides Elevator information - For use in International Concourses only : Accent Color Yellow - Pantone 123

2.0 SIGN TYPES

#	REVISION	DATE
1	Updated	05/06/16
2	Updated	09/19/17

2.3 Sign Type Index

ST-360 Primary Informational - Wall Mounted		
Domestic Concourses	N/A	International Concourses
		
- Overall dimensions: 1'- 6" H x 10" W x 1" D - Provides information on Transportation Malls levels and functions	N/A	- Overall dimensions: 1'- 6" H x 10" W x 1" D - Provides information on Transportation Malls levels and functions
N/A		
N/A	N/A	N/A
N/A	N/A	N/A
N/A		
N/A	N/A	N/A
N/A	N/A	N/A
N/A		
N/A	N/A	N/A
N/A	N/A	N/A

2.0 SIGN TYPES

#	REVISION	DATE
1	Updated	05/06/16
2	Updated	09/19/17

2.4 Sign Type Layouts

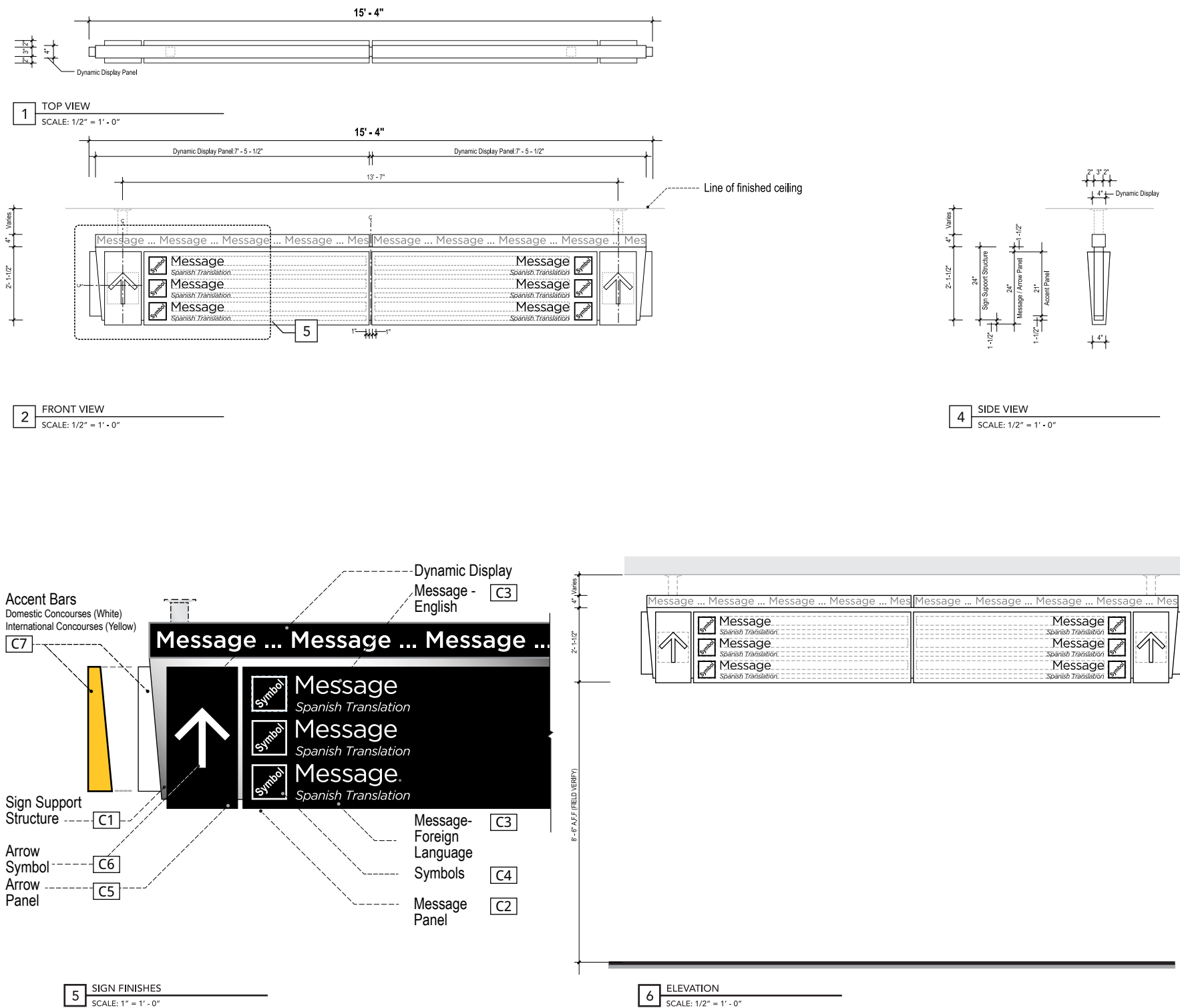

Directional **ST-302**

Descriptions: Primary Directional (Dynamic)
2 Directionals / 3 Levels of messaging / 2 sided.

Dimensions: 2'- 5 1/2" High x 15' - 4" Wide x 7" Depth
Dynamic Display Bar: 4" H x 7'- 5-1/2"W x 4" D

Location: Transportation Malls. Primary circulation corridors - perpendicular to the main pedestrian traffic flow.

Material: Seamless fabricated aluminum sign panel with removable message and arrow panels.

Lettering: 1. English - Gotham Book - 4" Cap height
2. Spanish - Gotham Book - 2" Cap height

Symbology: Refer to Section 1 - Graphics Standards

- Colors:**
- C1** • Sign Support Structure
- Seamless fabricated .125" ALUMINUM (satin brushed)
 - C2** • Message Panel
- .25" seamless fabricated WHITE ACRYLIC (Translucent Sign Grade Polycarbonate) with BLACK VINYL overlay. LED Internally illuminated.
 - C3** • Messages - English - Foreign Language
- Internally illuminated (White)
 - C4** • Symbols
- Internally illuminated (White)
 - C5** • Arrow Panels
- .25" seamless fabricated WHITE ACRYLIC (Translucent Sign Grade Polycarbonate) with BLACK VINYL overlay. LED Internally illuminated.
 - C6** • Arrow Symbol
- Internally illuminated (White)
 - C7** • Accent Bars
- 125" seamless bent acrylic with top and bottom caps. LED Internally illuminated. Accent Bar colors :
Domestic Concourses - White Acrylic
International Concourses - Pantone 123 (Yellow) - Locations T.B.D.: Assigned by Owner / Owner's Rep.
 - C8** • Mounting Support
- .080" x 3" square extruded ALUMINUM (satin brushed) tube to attach to existing building support sub-structure. Field verify.

Graphics: N/A
Mounting: Ceiling suspended
Illumination: Internal

Notes:

1. Signs with directional messages to Domestic Terminal will utilize "white" accent bar (White Acrylic) only..
2. Signs with messages for International Terminal will utilize "yellow" accent bar (Pantone 123) only.
3. Colors are not interchangeable, and cannot be substituted.

Colors con't.:

Remarks: Dynamic display messages will vary per Owner's request.

2.0 SIGN TYPES

#	REVISION	DATE
1	Updated	05/06/16
2	Updated	09/19/17

2.4 Sign Type Layouts

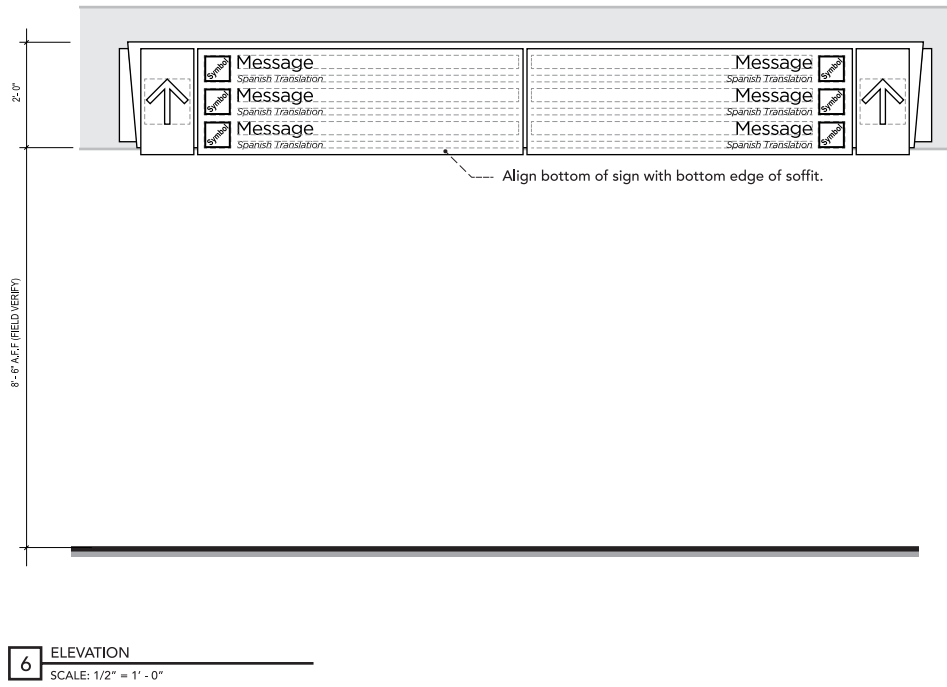
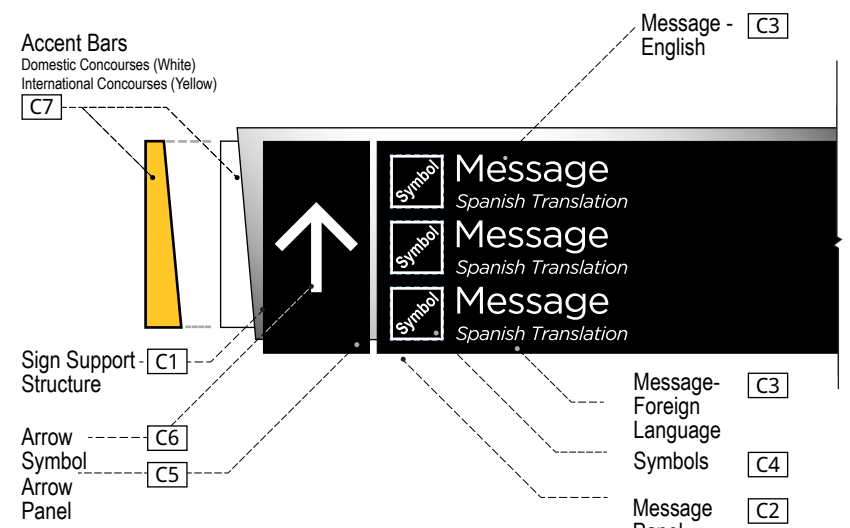
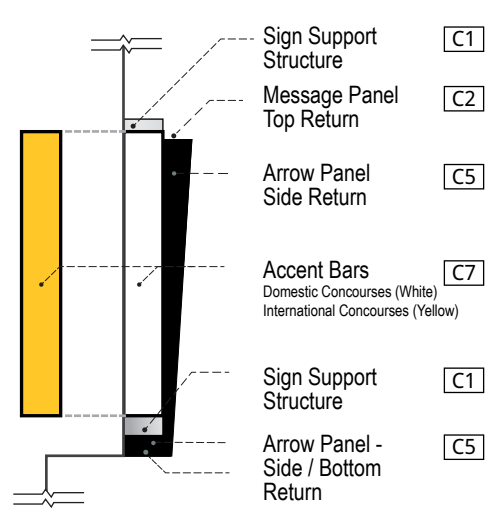
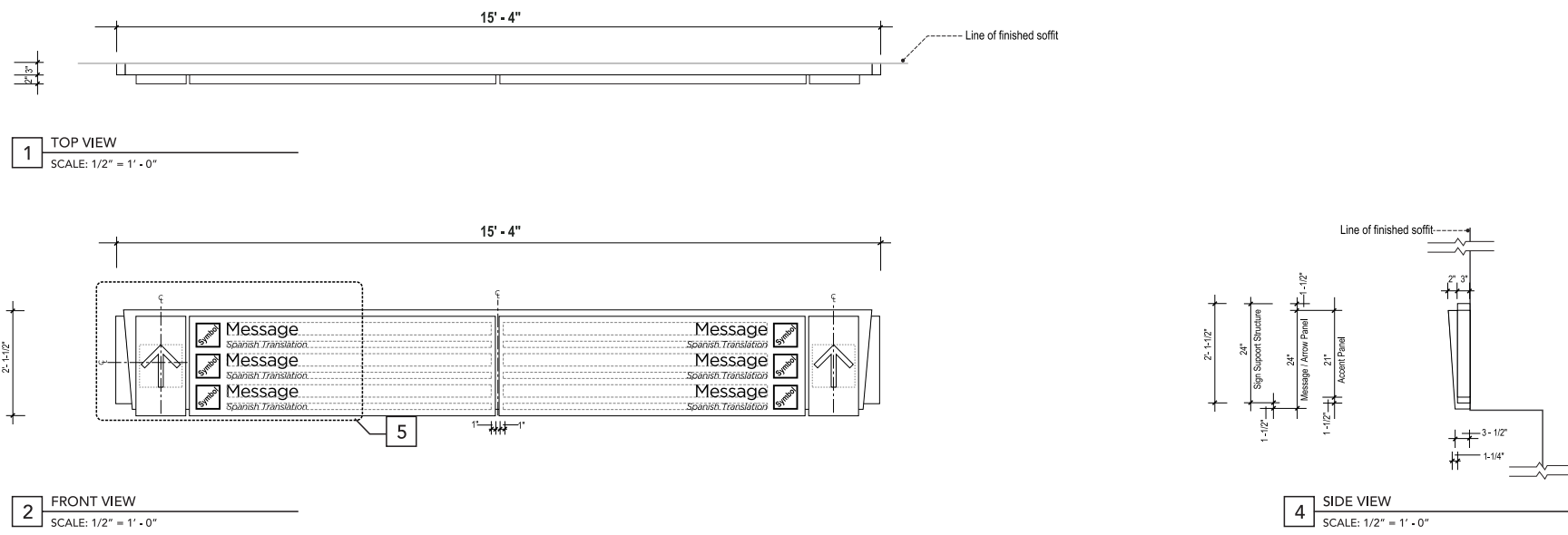

Directional ST-304

- Descriptions:** Primary Directional
2 Directionals / 3 Levels of messaging / 1 sided.
- Dimensions:** 2'- 1 1/2" High x 15' - 4" Wide x 5" Depth
- Location:** Transportation Malls. Primary circulation corridor - perpendicular to the main pedestrian traffic flow.
- Material:** Seamless fabricated aluminum sign panel with removable message and arrow panels.
- Lettering:**
1. English - Gotham Book - 4" Cap height
2. Spanish - Gotham Book - 2" Cap height
- Symbology:** Refer to Section 1- Graphics Standards
- Colors:**
- [C1] Sign Support Structure
- Seamless fabricated .125" ALUMINUM (satin brushed)
 - [C2] Message Panel
-.25" seamless fabricated WHITE ACRYLIC (Translucent Sign Grade Polycarbonate) with opaque BLACK VINYL overlay. LED Internally illuminated.
 - [C3] Messages - English and Foreign Language
- Internally illuminated (White)
 - [C4] Symbols
- Internally illuminated (White)
 - [C5] Arrow Panels
-.25" seamless fabricated WHITE ACRYLIC (Translucent Sign Grade Polycarbonate) with opaque BLACK VINYL overlay. LED Internally illuminated.
 - [C6] Arrow Symbol
- Internally illuminated (White)
 - [C7] Accent Bars
- 125" seamless bent acrylic with top and bottom caps. LED Internally illuminated.
Accent Bar colors :
Domestic Concourses - White Acrylic
International Concourses - Pantone 123 (Yellow) - Locations T.B.D.: Assigned by Owner / Owner's Rep.
- Graphics:** N/A
Mounting: Soffit Mounted
Illuminations: Internal
Remarks:

Notes:

1. Signs with directional messages to Domestic Terminal will utilize "white" accent bar (White Acrylic) only..
2. Signs with messages for International Terminal will utilize "yellow" accent bar (Pantone 123) only.
3. Colors are not interchangeable, and cannot be substituted.

2.0 SIGN TYPES

#	REVISION	DATE
1	Updated	05/06/16
2	Updated	09/19/17

2.4 Sign Type Layouts

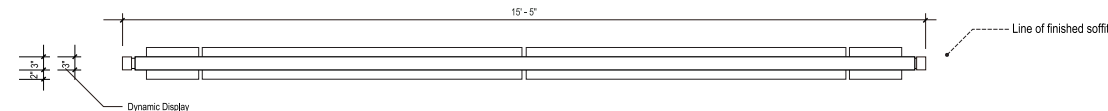

1 TOP VIEW
SCALE: 1/2" = 1' - 0"

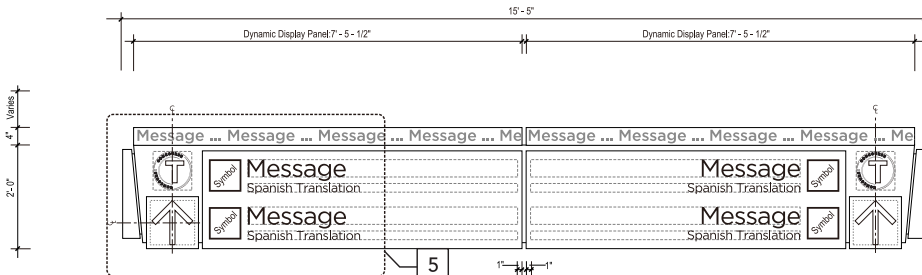

2 FRONT VIEW
SCALE: 1/2" = 1' - 0"

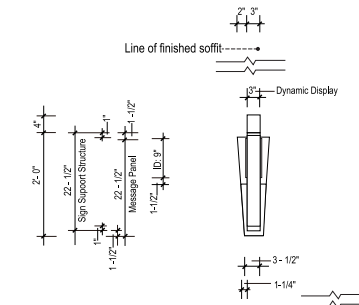

4 SIDE VIEW
SCALE: 1/2" = 1' - 0"

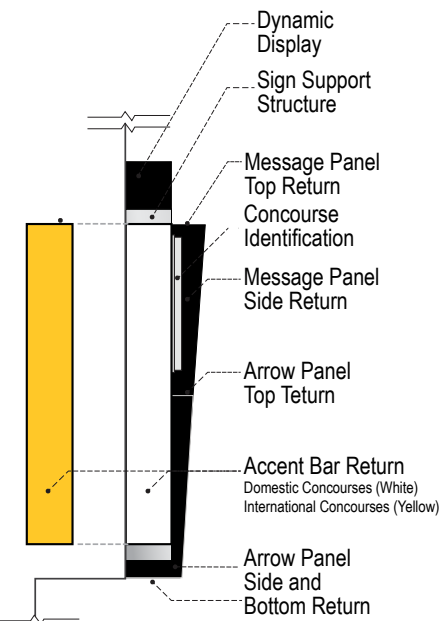

4 SIGN FINISHES - END VIEW
SCALE: NTS

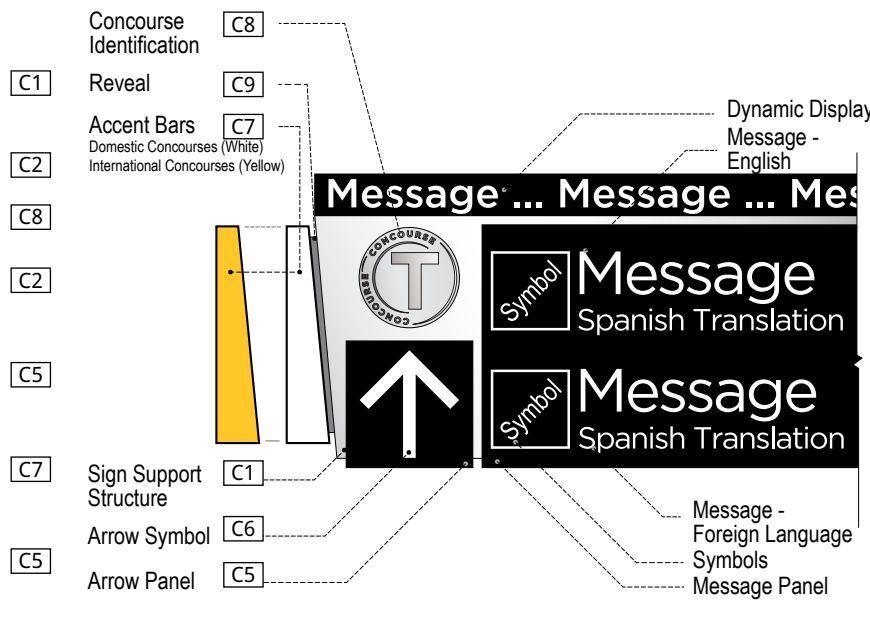

6 SIGN FINISHES
SCALE: NTS



5 CONCOURSE IDENTIFICATION
SCALE: NTS

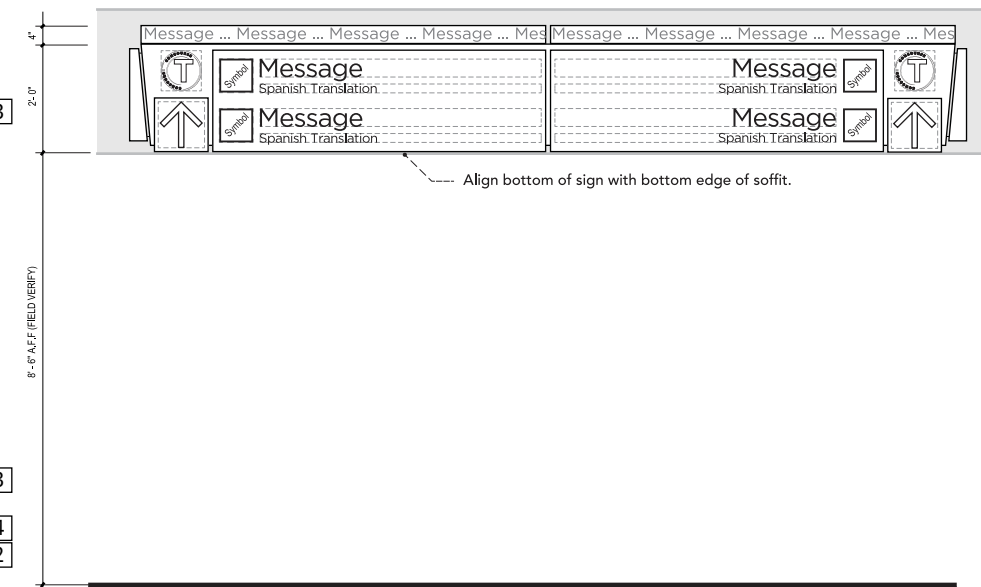

7 ELEVATION
SCALE: 1/2" = 1' - 0"

Colors con't.:

Remarks:

Soffit Mount:

- Soffit at decision point
- Maintain 8' -6" A.F.F

Dynamic display messages will vary per Owner's request.

Directional ST-306

Descriptions: Primary Directional (Dynamic)
2 Directionals / 2 Levels of messaging / 2 sided.

Dimensions: 2'- 4" High x 15'- 5" Wide x 5" Depth
Dynamic Display Bar: 4" H x 7'- 5-1/2"W x 4" D

Location: Transportation Malls. Primary circulation corridor - perpendicular to the main pedestrian traffic flow.

Material: Seamless fabricated aluminum sign panel with removable message and arrow panels.

Lettering: 1. English - Gotham Book - 4" Cap height
2. Spanish - Gotham Book - 2" Cap height

Symbology: Refer to Section 1- Graphics Standards

- Colors:**
- C1** • Sign Support Structure
- Seamless fabricated .125" ALUMINUM (satin brushed)
 - C2** • Message Panel
-.25" seamless fabricated WHITE ACRYLIC (Translucent Sign Grade Polycarbonate) with opaque BLACK VINYL overlay. LED Internally illuminated.
 - C3** • Messages - English and Foreign Language
- Internally illuminated (White)
 - C4** • Symbols
- Internally illuminated (White)
 - C5** • Arrow Panels
-.25" seamless fabricated WHITE ACRYLIC (Translucent Sign Grade Polycarbonate) with opaque BLACK VINYL overlay. LED Internally illuminated.
 - C6** • Arrow Symbol
- Internally illuminated (White)
 - C7** • Accent Bars
- 125" seamless bent acrylic with top and bottom caps. LED Internally illuminated. Accent Bar colors :
Domestic Concourses - White Acrylic
International Concourses - Pantone 123 (Yellow) - Locations T.B.D.: Assigned by Owner / Owner's Rep.
 - C8** • Concourse Identification
- .25" ALUMINUM (satin brushed) dimensional machine cut letters mounted onto .125" circular ALUMINUM (satin brushed) disc.
 - C9** • Reveal
- Seamless fabricated .125" ALUMINUM (satin brushed)

Graphics: N/A
Mounting: Soffit Mounted
Illuminations: Internal

- Notes:**
1. Signs with directional messages to Domestic Terminal will utilize "white" accent bar (White Acrylic) only..
 2. Signs with messages for International Terminal will utilize "yellow" accent bar (Pantone 123) only.
 3. Colors are not interchangeable, and cannot be substituted.

2.0 SIGN TYPES

#	REVISION	DATE
1	Updated	05/06/16
2	Updated	09/19/17

2.4 Sign Type Layouts

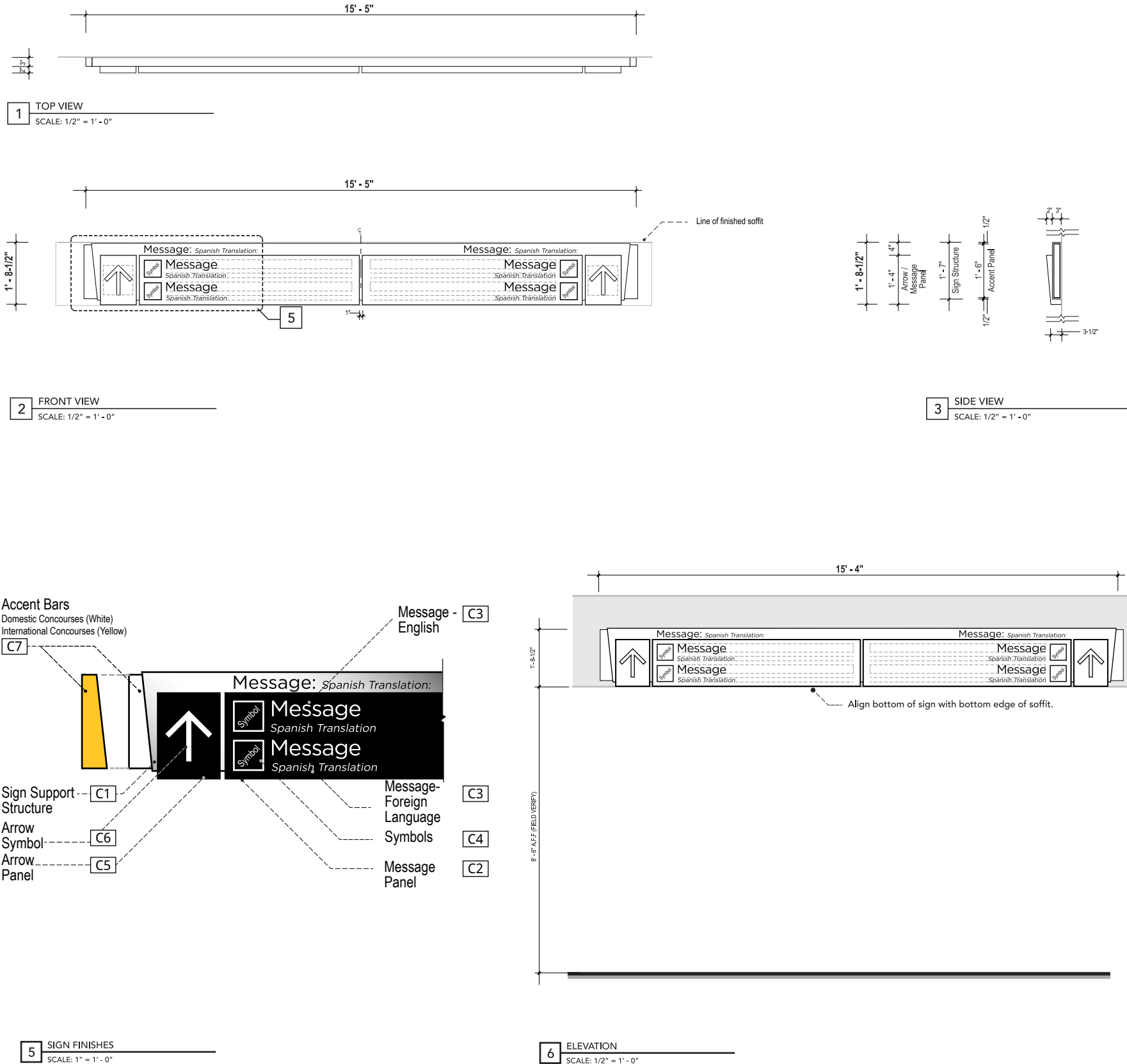

Directional **ST-312**

- Descriptions:** Primary Directional
2 Directionals / 2 Levels of messaging / 1 sided.
- Dimensions:** 1' - 8-1/2" High x 15' - 5" Wide x 5" Depth
- Location:** Transportation Malls. Primary circulation corridor - perpendicular to the main pedestrian traffic flow.
- Material:** Seamless fabricated aluminum sign panel with removable message and arrow panels.
- Lettering:**
1. English - Gotham Book - 4" Cap height
2. Spanish - Gotham Book - 2" Cap height
- Symbology:** Refer to Section 1- Graphics Standards
- Colors:**
- C1** • Sign Support Structure
 - Seamless fabricated .125" ALUMINUM (satin brushed)
 - C2** • Message Panel
 - .25" seamless fabricated WHITE ACRYLIC (Translucent Sign Grade Polycarbonate) with opaque BLACK VINYL overlay. LED Internally illuminated.
 - C3** • Messages - English and Foreign Language
 - Internally illuminated (White)
 - C4** • Symbols
 - Internally illuminated (White)
 - C5** • Arrow Panels
 - .25" seamless fabricated WHITE ACRYLIC (Translucent Sign Grade Polycarbonate) with opaque BLACK VINYL overlay. LED Internally illuminated.
 - C6** • Arrow Symbol
 - Electronically cut out overlay. LED Internally illuminated.
 - C7** • Accent Bars
 - .125" seamless bent acrylic with top and bottom caps. LED Internally illuminated.
 - Accent Bar colors :
Domestic Concourses - White Acrylic
International Concourses - Pantone 123 (Yellow) - Locations T.B.D.: Assigned by Owner / Owner's Rep.
- Graphics:** N/A
Mounting: Ceiling Mounted
Illuminations: Internal
Remarks: Soffit Mount:
- Soffit at decision point
- Maintain 8' - 6" A.F.F

Notes:

- Signs with directional messages to Domestic Terminal will utilize "white" accent bar (White Acrylic) only..
- Signs with messages for International Terminal will utilize "yellow" accent bar (Pantone 123) only.
- Colors are not interchangeable, and cannot be substituted.

2.0 SIGN TYPES

#	REVISION	DATE
1	Updated	05/06/16
2	Updated	09/19/17

2.4 Sign Type Layouts

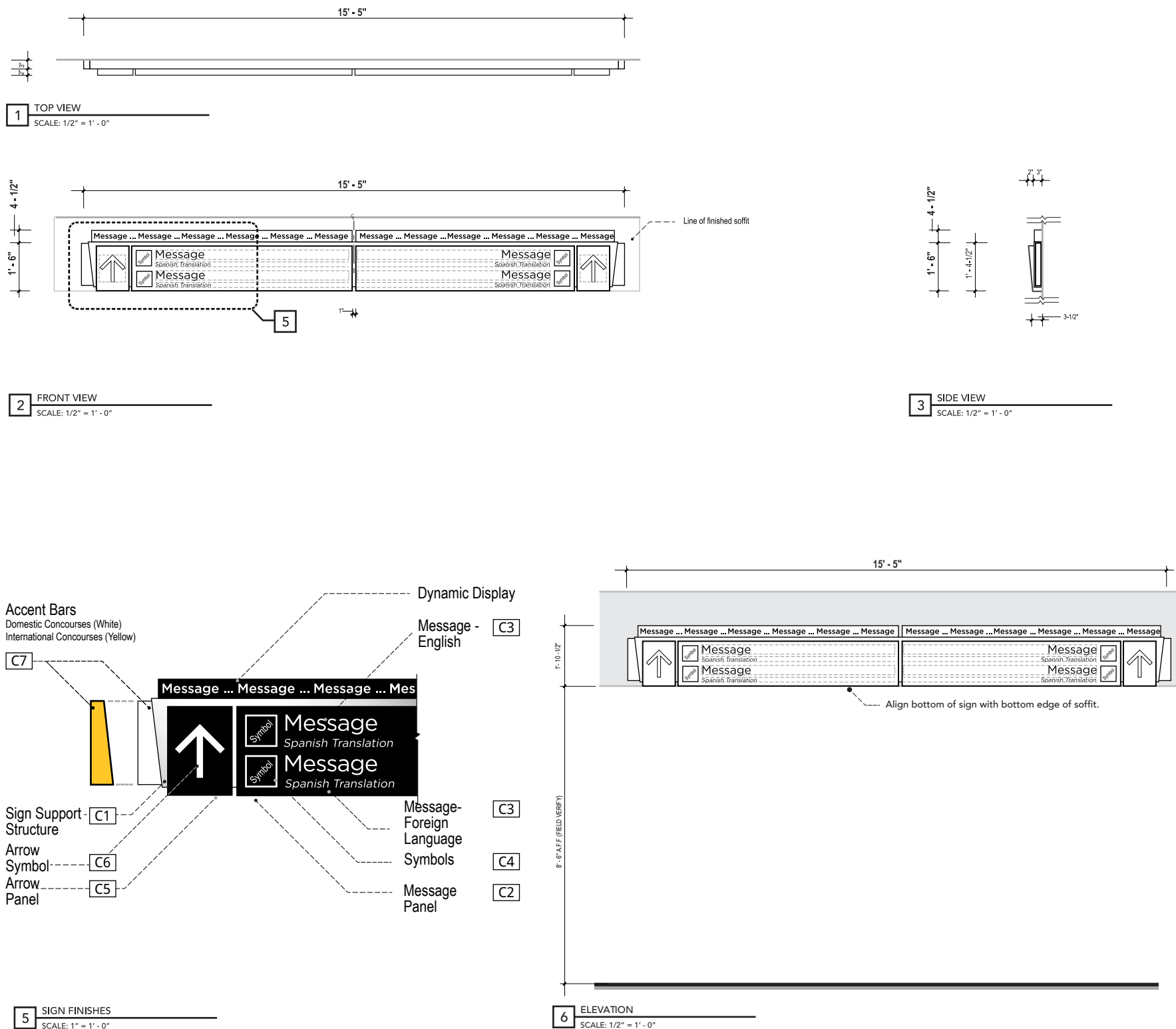

Directional **ST-314**

Descriptions: Primary Directional (Dynamic)
2 Directionals / 2 Levels of messaging / 1 sided.

Dimensions: 1'- 10-1/2" High x 15'- 5" Wide x 5" Depth
Dynamic Display Bar: 4 1/2" H x 7'- 5-1/2"W x 3" D

Location: Transportation Malls. Primary circulation corridor - perpendicular to the main pedestrian traffic flow.

Material: Seamless fabricated aluminum sign panel with removable message and arrow panels.

Lettering: 1. English - Gotham Book - 4" Cap height
2. Spanish - Gotham Book - 2" Cap height

Symbology: Refer to Section 1- Graphics Standards

Colors:

- [C1] • Sign Support Structure
- Seamless fabricated .125" ALUMINUM (satin brushed)
- [C2] • Message Panel
- .25" seamless fabricated WHITE ACRYLIC (Translucent Sign Grade Polycarbonate) with opaque BLACK VINYL overlay. LED Internally illuminated.
- [C3] • Messages - English and Foreign Language
- Internally illuminated (White)
- [C4] • Symbols
- Internally illuminated (White)
- [C5] • Arrow Panels
- .25" seamless fabricated WHITE ACRYLIC (Translucent Sign Grade Polycarbonate) with opaque BLACK VINYL overlay. LED Internally illuminated.
- [C6] • Arrow Symbol
- Electronically cut out overlay. LED Internally illuminated.
- [C7] • Accent Bars
- .125" seamless bent acrylic with top and bottom caps. LED Internally illuminated.
Accent Bar colors :
Domestic Concourses - White Acrylic
International Concourses - Pantone 123 (Yellow) - Locations T.B.D.: Assigned by Owner / Owner's Rep.

Graphics: N/A
Mounting: Wall / Soffit Mounted
Illuminations: Internal
Remarks: Soffit Mount:
- Soffit at decision point
- Maintain 8' - 6" A.F.F
Dynamic display messages will vary per Owner's request.

Notes:

- Signs with directional messages to Domestic Terminal will utilize "white" accent bar (White Acrylic) only.
- Signs with messages for International Terminal will utilize "yellow" accent bar (Pantone 123) only.
- Colors are not interchangeable, and cannot be substituted.

2.0 SIGN TYPES

#	REVISION	DATE
1	Updated	05/06/16
2	Updated	09/19/17

2.4 Sign Type Layouts

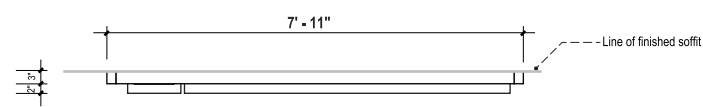

1 TOP VIEW
SCALE: 1/2" = 1' - 0"

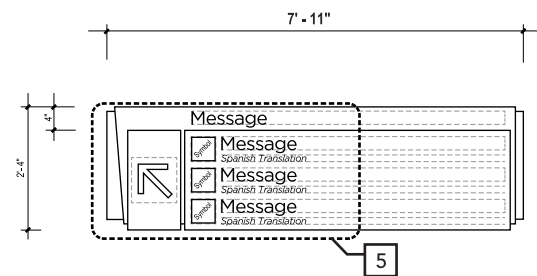

2 FRONT VIEW
SCALE: 1/2" = 1' - 0"

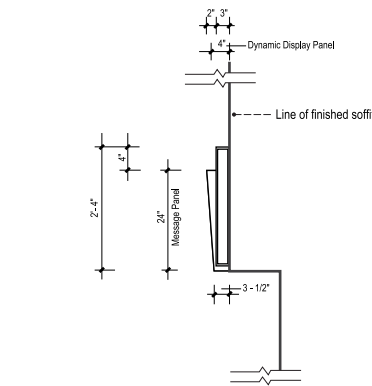

3 SIDE VIEW - SOFFIT MOUNT
SCALE: 1/2" = 1' - 0"

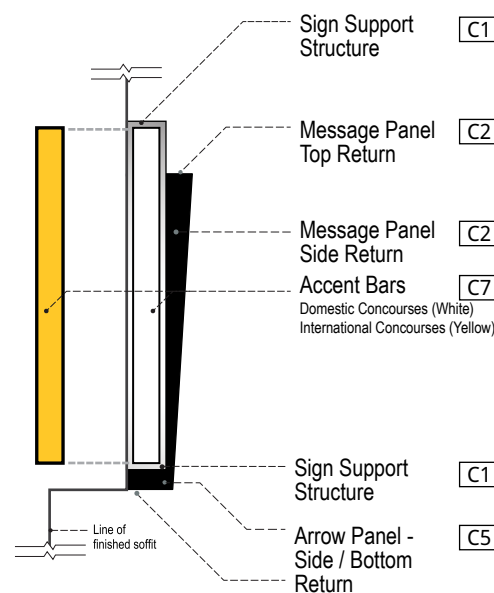

4 SIGN FINISHES - END VIEW
SCALE: 1-1/2" = 1' - 0"

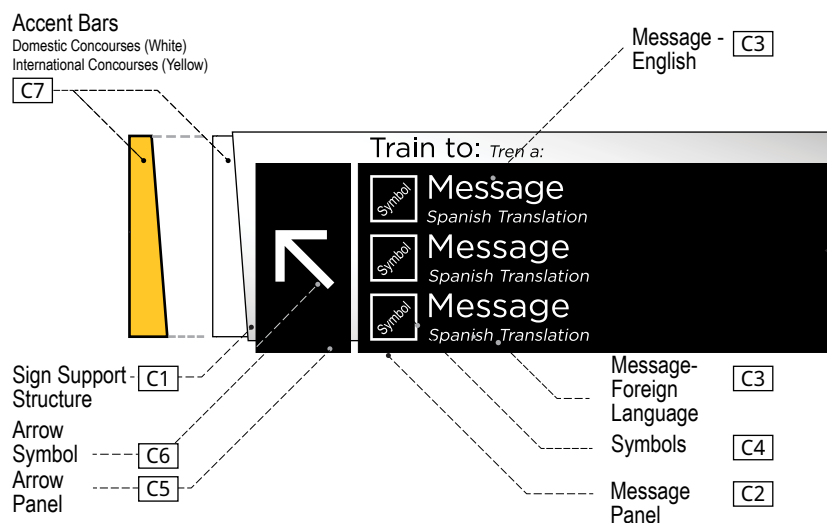

5 SIGN FINISHES
SCALE: 1" = 1' - 0"

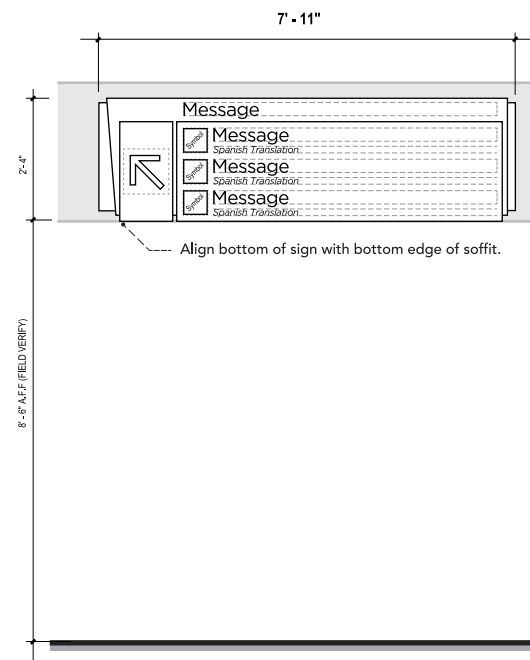

6 ELEVATION - SOFFIT
SCALE: 1/2" = 1' - 0"

Directional ST-320

Descriptions: Primary Directional
1 Directional / 3 Levels of messaging / 1 sided.

Dimensions: 2'- 4" High x 7' - 11" Wide x 5" Deep

Location: Transportation Malls. Primary circulation corridor - perpendicular to the main pedestrian traffic flow.

Material: Seamless fabricated aluminum sign panel with removable message and arrow panels.

Lettering:
1. English - Gotham Book - 4" Cap height
2. Spanish - Gotham Book - 2" Cap height

Symbology: Refer to Section 1- Graphics Standards

- Colors:**
- C1** • Sign Support Structure
- Seamless fabricated .125" ALUMINUM (satin brushed)
 - C2** • Message Panel
-.25" seamless fabricated WHITE ACRYLIC (Translucent Sign Grade Polycarbonate) with opaque BLACK VINYL overlay. LED Internally illuminated.
 - C3** • Message
- Internally illuminated (White)
 - C4** • Symbols
- Internally illuminated (White)
 - C5** • Arrow Panels
-.25" seamless fabricated WHITE ACRYLIC (Translucent Sign Grade Polycarbonate) with opaque BLACK VINYL overlay. LED Internally illuminated.
 - C6** • Arrow Symbol
- Internally illuminated (White)
 - C7** • Accent Bars
- .125" seamless bent acrylic with top and bottom caps. LED Internally illuminated.
Accent Bar colors :
Domestic Concourses - White Acrylic
International Concourses - Pantone 123 (Yellow) - Locations T.B.D.: Assigned by Owner / Owner's Rep.

Graphics: N/A
Mounting: Soffit Mounted
Illuminations: Internal
Remarks:
- Soffit Mount:
- Soffit at decision point
- Maintain 8' - 6" A.F.F

Notes:
1. Signs with directional messages to Domestic Terminal will utilize "white" accent bar (White Acrylic) only.
2. Signs with messages for International Terminal will utilize "yellow" accent bar (Pantone 123) only.
3. Colors are not interchangeable, and cannot be substituted.

2.0 SIGN TYPES

#	REVISION	DATE
1	Updated	05/06/16
2	Updated	09/19/17

2.4 Sign Type Layouts

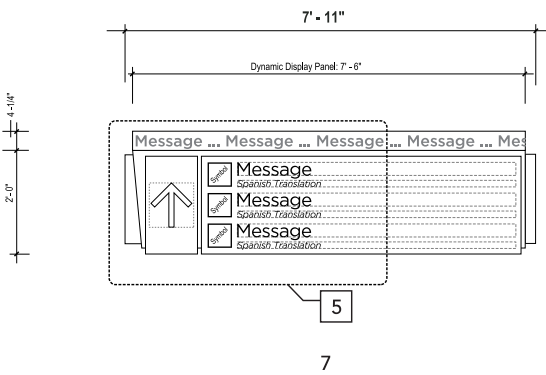
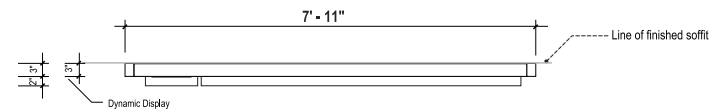

1 TOP VIEW
SCALE: 1/2" = 1' - 0"

2 FRONT VIEW
SCALE: 1/2" = 1' - 0"

- Notes:
1. Signs with directional messages to Domestic Terminal will utilize "white" accent bar (White Acrylic) only..
 2. Signs with messages for International Terminal will utilize "yellow" accent bar (Pantone 123) only.
 3. Colors are not interchangeable, and cannot be substituted.

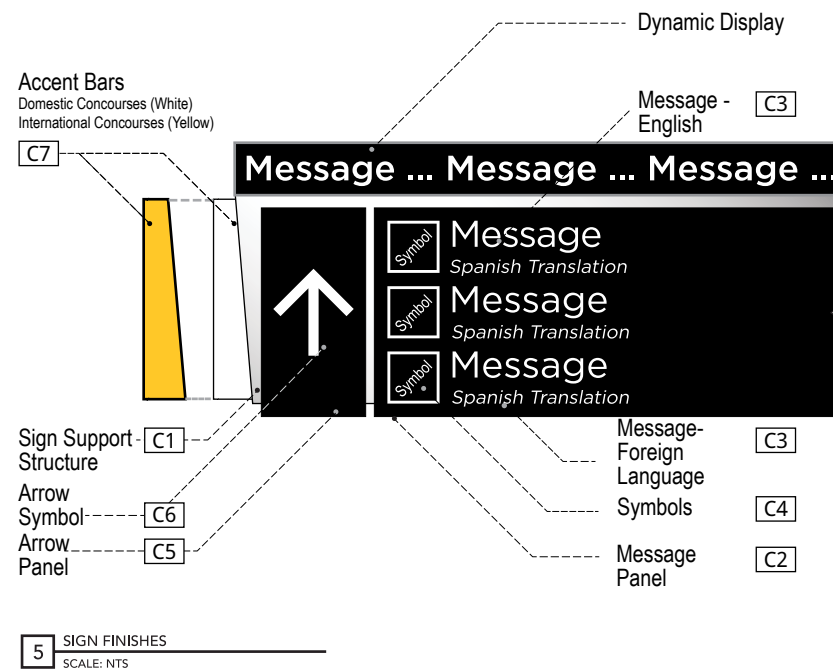
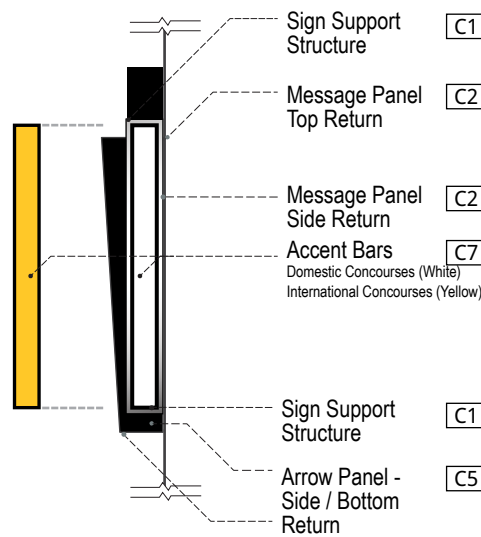
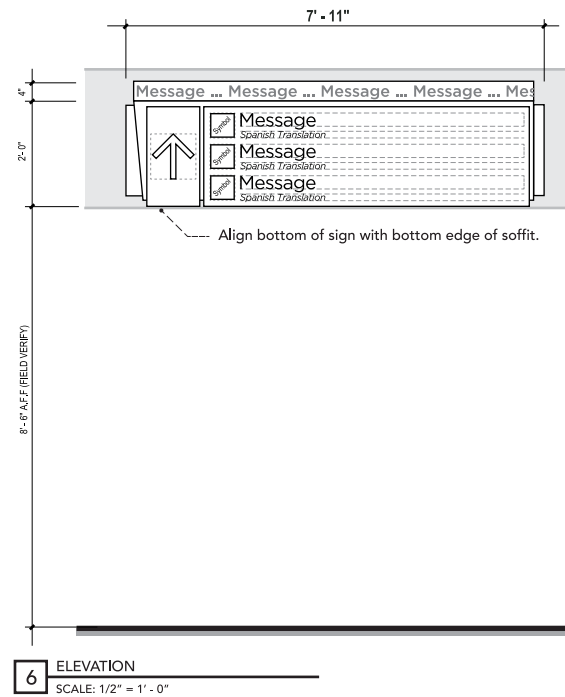
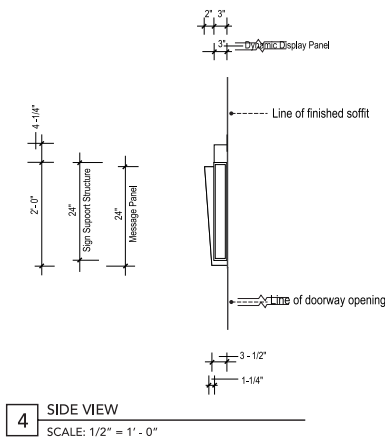

Colors con't.:

- Remarks:
- Soffit Mount:
 - Soffit at decision point
 - Maintain 8' - 6" A.F.F
 - Dynamic display messages will vary per Owner's request.

Directional **ST-322**

Descriptions: Primary Directional (Dynamic).
1 Directional / 3 Levels of messaging / 1 sided.

Dimensions: 2'- 4 1/4" High x 7' - 11" Wide x 5" Deep
Dynamic Display Bar: 4" H x 7'- 6"W x 4" D

Location: Transportation Malls. Primary circulation corridor - perpendicular to the main pedestrian traffic flow.

Material: Seamless fabricated aluminum sign panel with removable message and arrow panels.

Lettering: 1. English - Gotham Book - 4" Cap height
2. Spanish - Gotham Book - 2" Cap height

Symbology: Refer to Section 1- Graphics Standards

- Colors:**
- [C1] Sign Support Structure
 - Seamless fabricated .125" ALUMINUM (satin brushed)
 - [C2] Message Panel
 - .25" seamless fabricated WHITE ACRYLIC (Translucent Sign Grade Polycarbonate) with opaque BLACK VINYL overlay. LED Internally illuminated.
 - [C3] Message
 - Internally illuminated (White)
 - [C4] Symbols
 - Internally illuminated (White)
 - [C5] Arrow Panels
 - .25" seamless fabricated WHITE ACRYLIC (Translucent Sign Grade Polycarbonate) with opaque BLACK VINYL overlay. LED Internally illuminated.
 - [C6] Arrow Symbol
 - Internally illuminated (White)
 - [C7] Accent Bars
 - .125" seamless bent acrylic with top and bottom caps. LED Internally illuminated.
 - Accent Bar colors :
 - Domestic Concourses - White Acrylic
 - International Concourses - Pantone 123 (Yellow) - Locations T.B.D.: Assigned by Owner / Owner's Rep.
 - [C8] Refer to Section 1 - Graphics Standards Concourses Identification
 - .25" ALUMINUM (satin brushed) dimensional machine cut letters mounted onto .125" circular ALUMINUM (satin brushed) disc.
 - [C9] Reveal
 - Seamless fabricated .125" ALUMINUM (satin brushed)

Graphics: N/A
Mounting: Wall / Soffit Mounted
Illuminations: Internal

2.0 SIGN TYPES

#	REVISION	DATE
1	Updated	05/06/16
2	Updated	09/19/17

2.4 Sign Type Layouts

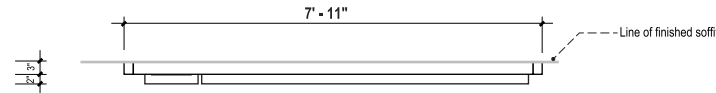

1 TOP VIEW
SCALE: 1/2" = 1' - 0"

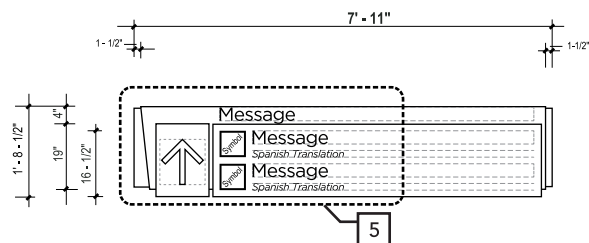

2 FRONT VIEW
SCALE: 1/2" = 1' - 0"

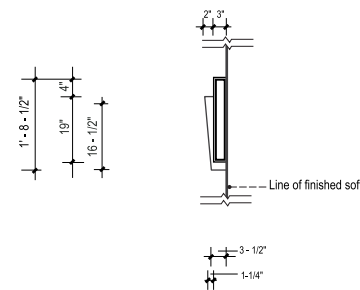

3 SIDE VIEW
SCALE: 1/2" = 1' - 0"

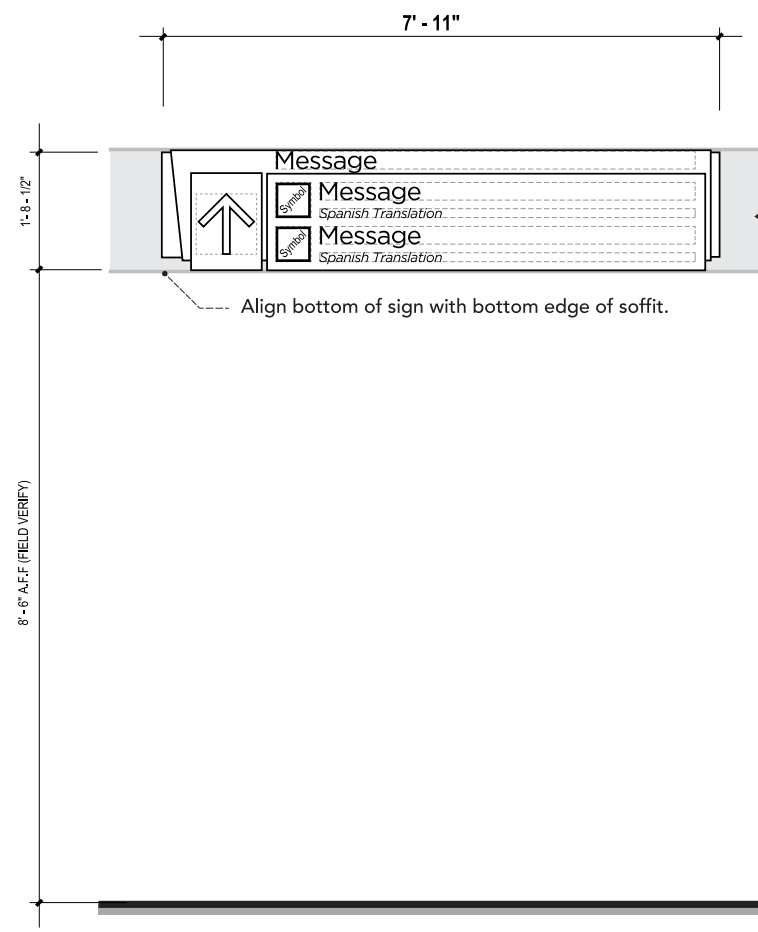

6 ELEVATION - SOFFIT
SCALE: 1/2" = 1' - 0"

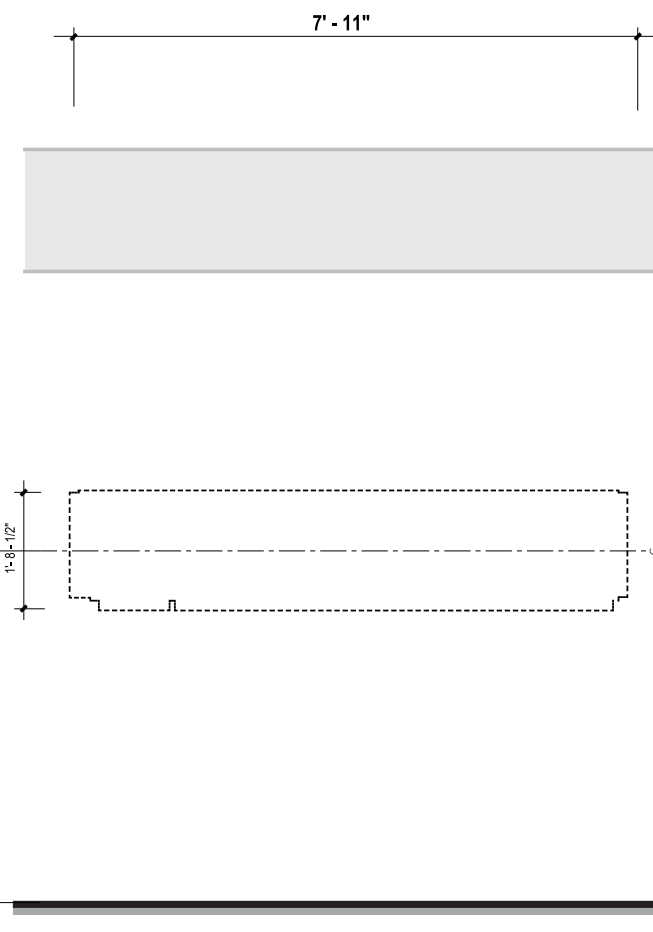

7 ELEVATION - WALL
SCALE: 1/2" = 1' - 0"

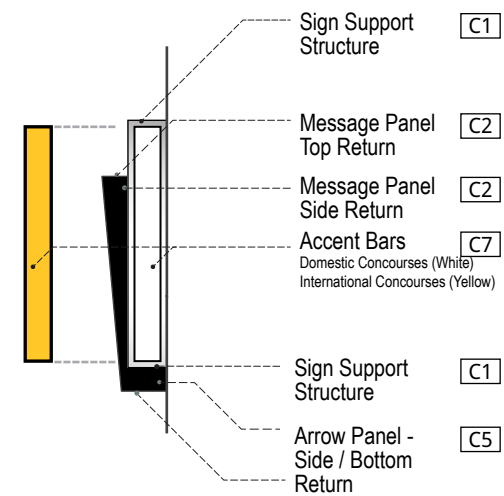

4 SIDE FINISHES - END VIEW
SCALE: 1-1/2" = 1' - 0"

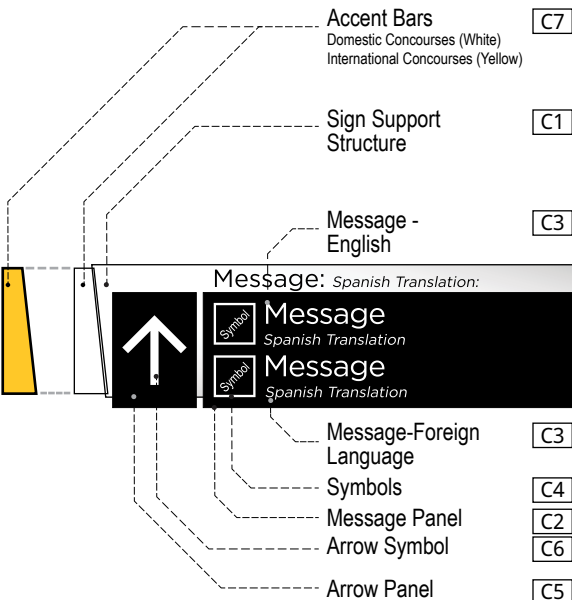

5 SIGN FINISHES
SCALE: NTS

Directional ST-328

- Descriptions:** Secondary Directional
1 Directionals / 2 Levels of messaging / 1 sided.
- Dimensions:** 1'- 8-1/2" High x 7' - 11" Wide x 5" Depth
- Location:** Transportation Malls. Primary circulation corridor - perpendicular to the main pedestrian traffic flow.
- Material:** Seamless fabricated aluminum sign panel with removable message and arrow panels.
- Lettering:**
1. English - Gotham Book - 4" Cap height
2. Spanish - Gotham Book - 2" Cap height
- Symbology:** Refer to Section 1- Graphics Standards
- Colors:**
- C1** • Sign Support Structure
- Seamless fabricated .125" ALUMINUM (satin brushed)
 - C2** • Message Panel
-.25" seamless fabricated WHITE ACRYLIC (Translucent Sign Grade Polycarbonate) with opaque BLACK VINYL overlay. LED Internally illuminated.
 - C3** • Message
- Internally illuminated (White)
 - C4** • Symbols
- Internally illuminated (White)
 - C5** • Arrow Panels
-.25" seamless fabricated WHITE ACRYLIC (Translucent Sign Grade Polycarbonate) with opaque BLACK VINYL overlay. LED Internally illuminated.
 - C6** • Arrow Symbol
- Internally illuminated (White)
 - C7** • Accent Bars
-.125" seamless bent acrylic with top and bottom caps. LED Internally illuminated.
Accent Bar colors :
Domestic Concourses - White Acrylic
International Concourses - Pantone 123 (Yellow) - Locations T.B.D.: Assigned by Owner / Owner's Rep.
- Graphics:** N/A
Mounting: Soffit / Wall Mounted
Illuminations: Internal
Remarks: Soffit Mount:
- Soffit at decision point
- Maintain 8' - 6" A.F.F

Notes:
1. Signs with directional messages to Domestic Terminal will utilize "white" accent bar (White Acrylic) only..
2. Signs with messages for International Terminal will utilize "yellow" accent bar (Pantone 123) only.
3. Colors are not interchangeable, and cannot be substituted.

2.0 SIGN TYPES

#	REVISION	DATE
1	Updated	05/06/16
2	Updated	09/19/17

2.4 Sign Type Layouts

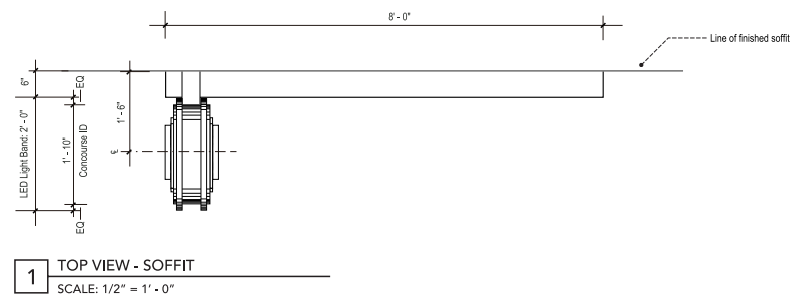

1 TOP VIEW - SOFFIT
SCALE: 1/2" = 1' - 0"

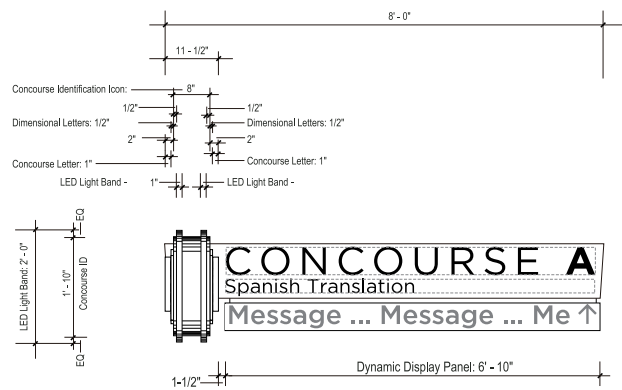

2 FRONT VIEW
SCALE: 1/2" = 1' - 0"

NOTE: Spanish Translation to be the same exact length as the Identification text "Concourse A". TYP.

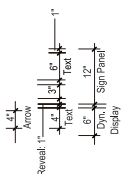

3 SIDE VIEW
SCALE: 1/2" = 1' - 0"

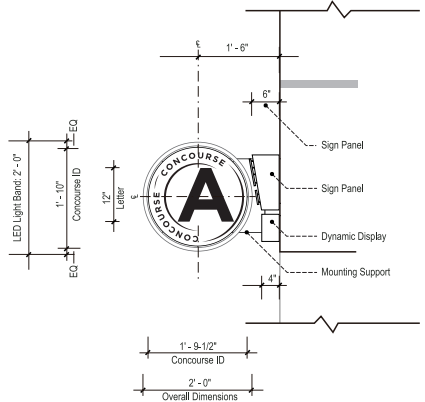

8 ELEVATION
SCALE: 1/2" = 1' - 0"

NOTE: Sign to be field located

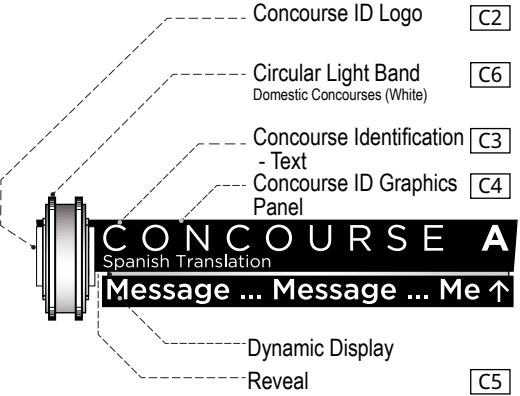

4 SIGN FINISHES
SCALE: 1" = 1' - 0"

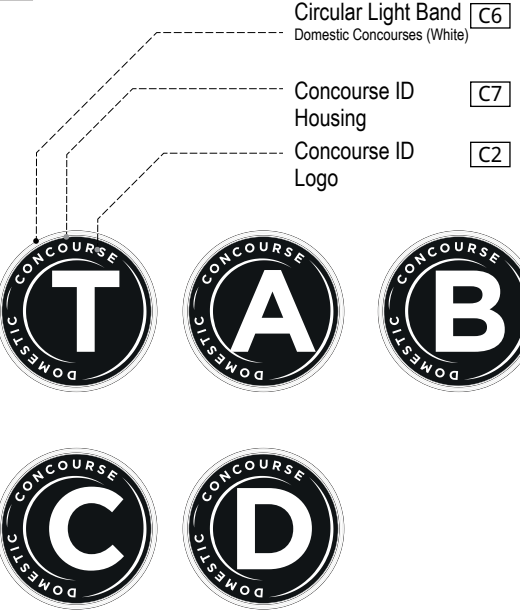

5 CONTOUR IDENTIFICATION
SCALE: NTS

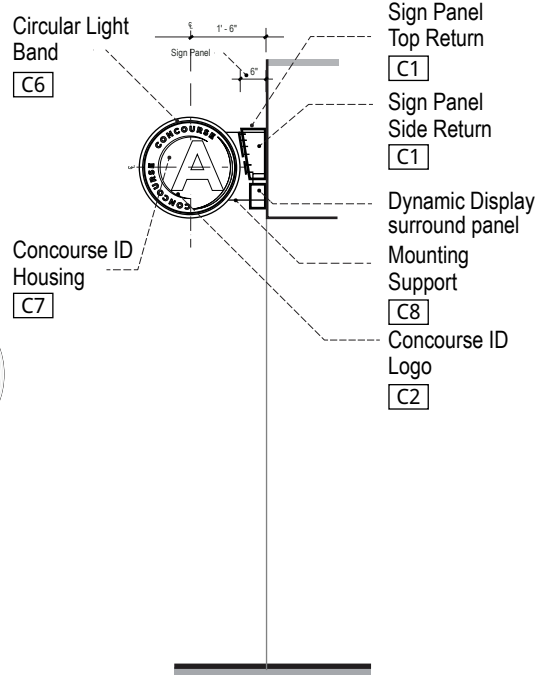

6 END VIEW - 1
SCALE: 1/2" = 1' - 0"

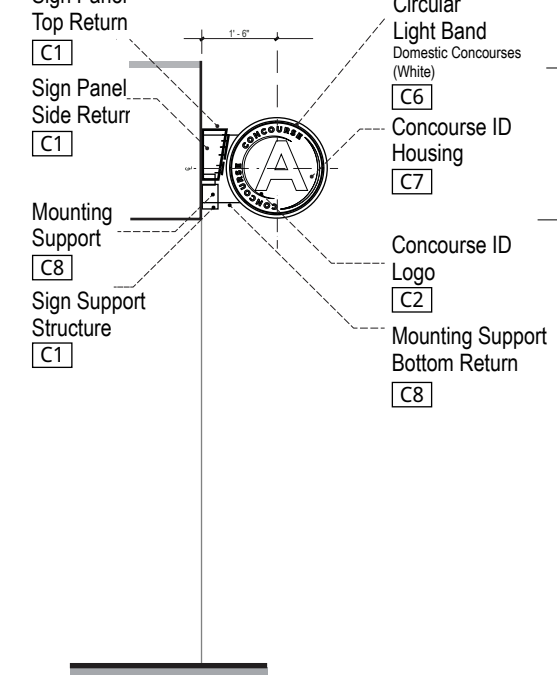

7 END VIEW - 2
SCALE: 1/2" = 1' - 0"

Identification **ST-342**

- Descriptions:** Primary Identification - Ceiling Mounted
- Dimensions:** 2'- 0" High x 8' - 0" Wide x 2' - 6" Depth
Dynamic Display Bar: 4" H x 6'- 10"W x 6" D
- Location:** Transportation Malls. Primary circulation corridors - perpendicular to the main pedestrian traffic flow.
- Material:** Seamless fabricated aluminum sign panel with removable message and arrow panels.
- Lettering:** 1. English - Gotham Book - 6" Cap height
- Symbology:** Refer to Section 1- Graphics Standards
- Colors:**
- [C1] • Sign Support Structure
- Seamless fabricated .125" ALUMINUM (Satin Brushed)
 - [C2] • Concourse ID Logo
- .25" ALUMINUM (Satin Brushed) dimensional machine cut letters mounted onto .125" circular ALUMINUM (Satin Brushed) disc.
 - [C3] • Concourse Identification Text
- Fabricated dimensional letters. LED Internally illuminated.
- WHITE ACRYLIC : Translucent Sign Grade Polycarbonate
 - [C4] • Concourse ID Graphic Panel
- .25" clear acrylic with graphics on second surface.
 - [C5] • Reveal
- Seamless fabricated .125" ALUMINUM (Satin Brushed)
 - [C6] • Circular Light Band
- 1" Thick x 2' - 9" Wide seamless fabricated WHITE ACRYLIC (Translucent Sign Grade Polycarbonate)
- LED Internally illuminated
 - [C7] • Concourse ID Housing
- Seamless fabricated .125" ALUMINUM (Satin Brushed)
 - [C8] • Mounting Support
- Seamless fabricated .125" ALUMINUM (Satin Brushed)

Graphics: N/A
Mounting: Ceiling Mounted
Illuminations: Internal
Remarks: Soffit Mount:
 - Soffit at decision point
 - Maintain 8' - 6" A.F.F.
 Dynamic messages will vary per Owner's request.

Note:
1. Colors are not interchangeable, and cannot be substituted.

2.0 SIGN TYPES

#	REVISION	DATE
1	Updated	05/06/16
2	Updated	09/19/17

2.4 Sign Type Layouts

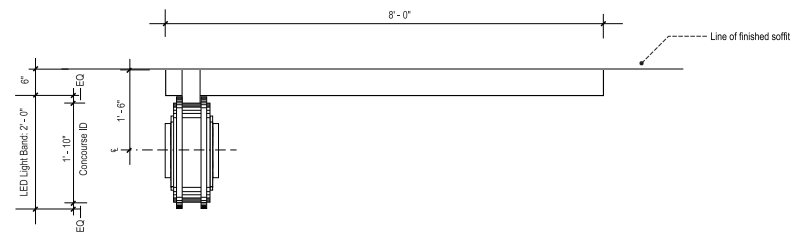

1 TOP VIEW - SOFFIT
SCALE: 1/2" = 1' - 0"

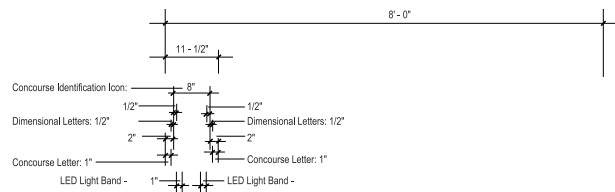

NOTE: Spanish Translation to be the same exact length as the Identification text "Concourse A". TYP.

2 FRONT VIEW
SCALE: 1/2" = 1' - 0"

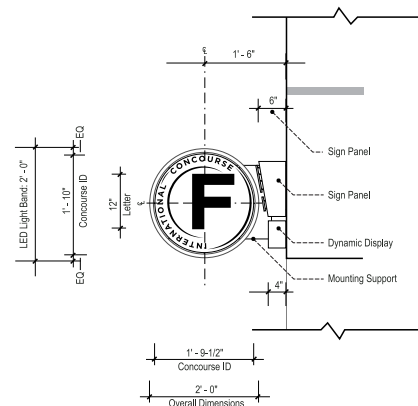

3 SIDE VIEW
SCALE: 1/2" = 1' - 0"

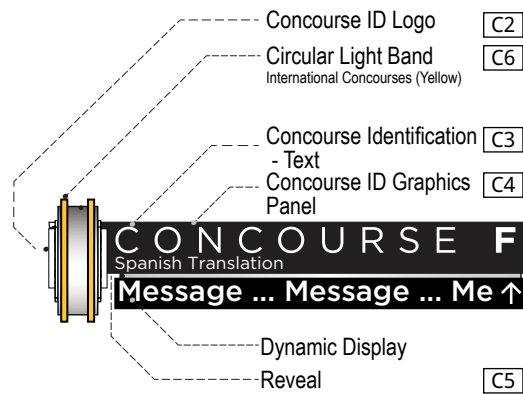

4 SIGN FINISHES
SCALE: 1" = 1' - 0"

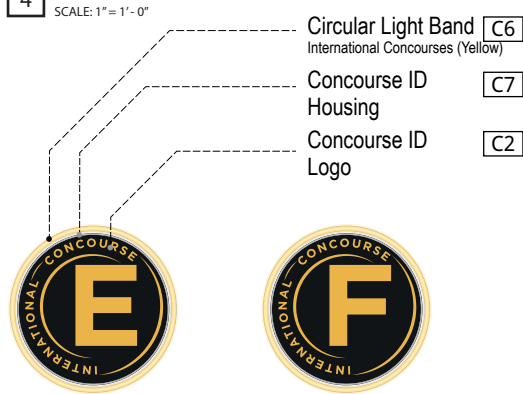

5 CONTOUR IDENTIFICATION
SCALE: NTS

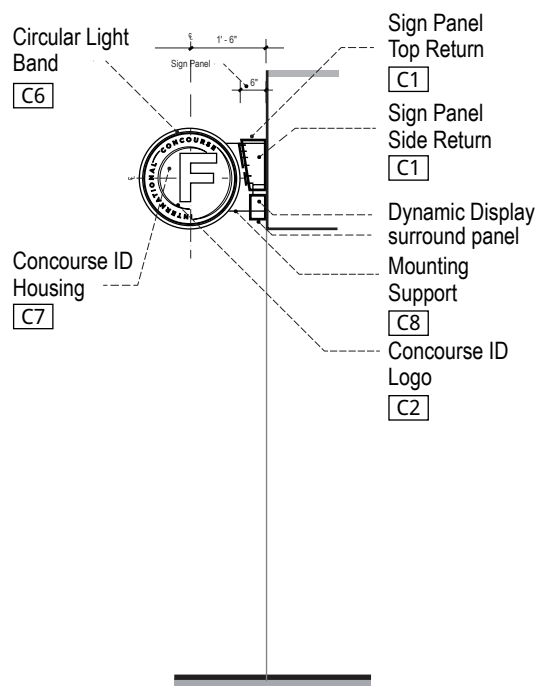

6 END VIEW - 1
SCALE: 1/2" = 1' - 0"

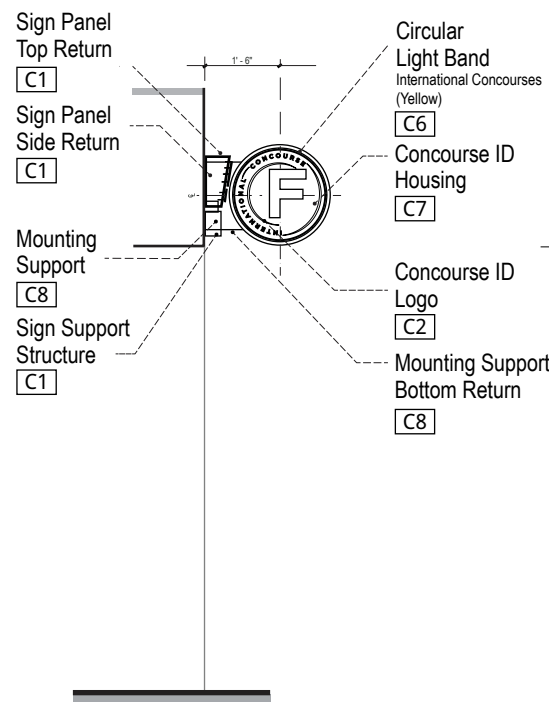

7 END VIEW - 2
SCALE: 1/2" = 1' - 0"

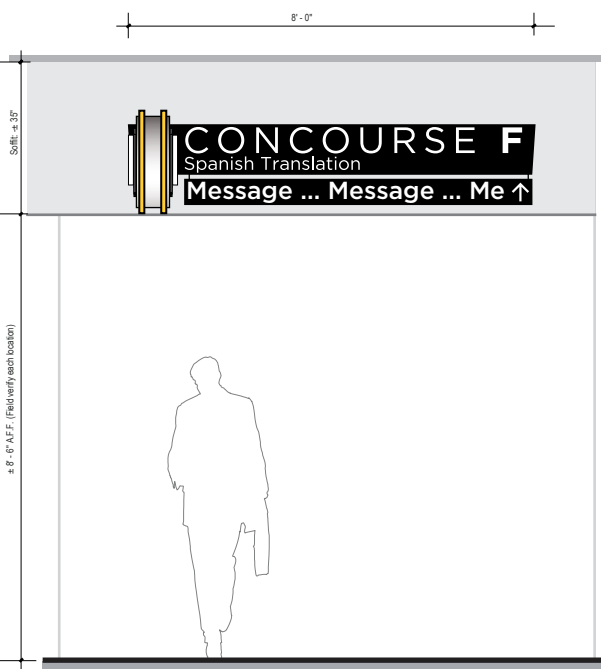

8 ELEVATION
SCALE: 1/2" = 1' - 0"

NOTE: Sign to be field located

Identification **ST-344**

- Descriptions:** Primary Identification - Ceiling Mounted
- Dimensions:** 2'- 0" High x 8' - 0" Wide x 2' - 6" Depth
Dynamic Display Bar: 4" H x 6'- 10"W x 6" D
- Location:** Transportation Malls. Primary circulation corridors - perpendicular to the main pedestrian traffic flow.
- Material:** Seamless fabricated aluminum sign panel with removable message and arrow panels.
- Lettering:** 1. English - Gotham Book - 6" Cap height
- Symbology:** Refer to Section 1- Graphics Standards
- Colors:**
- [C1] • Sign Support Structure
- Seamless fabricated .125" ALUMINUM (Satin Brushed)
 - [C2] • Concourse ID Logo
- .25" ALUMINUM (Satin Brushed) dimensional machine cut letters mounted onto .125" circular ALUMINUM (Satin Brushed) disc.
 - [C3] • Concourse Identification Text
- Fabricated dimensional letters. LED Internally illuminated.
- WHITE ACRYLIC : Translucent Sign Grade Polycarbonate
 - [C4] • Concourse ID Graphic Panel
- .25" clear acrylic with graphics on second surface.
 - [C5] • Reveal
- Seamless fabricated .125" ALUMINUM (Satin Brushed)
 - [C6] • Circular Light Band
- 1" Thick x 2' - 9" Wide seamless fabricated WHITE ACRYLIC (Translucent Sign Grade Polycarbonate)
- LED Internally illuminated
 - [C7] • Concourse ID Housing
- Seamless fabricated .125" ALUMINUM (Satin Brushed)
 - [C8] • Mounting Support
- Seamless fabricated .125" ALUMINUM (Satin Brushed)
- Graphics:** N/A
- Mounting:** Ceiling Mounted
- Illuminations:** Internal
- Remarks:** Soffit Mount:
- Soffit at decision point
- Maintain 8' - 6" A.F.F.
Dynamic messages will vary per Owner's request.

Note:
1. Colors are not interchangeable, and cannot be substituted.

2.0 SIGN TYPES

#	REVISION	DATE
1	Updated	05/06/16
2	Updated	09/19/17

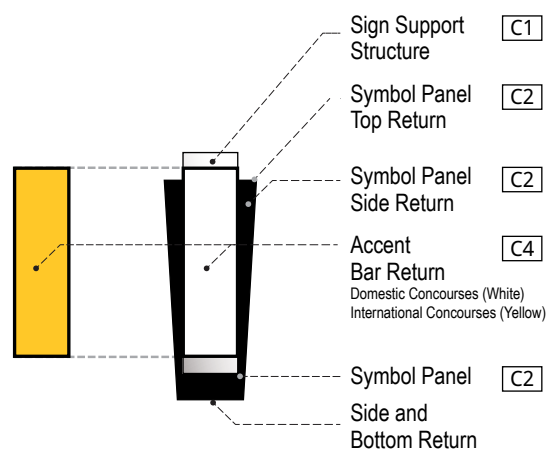

4 SIGN FINISHES - END VIEW
SCALE: NTS

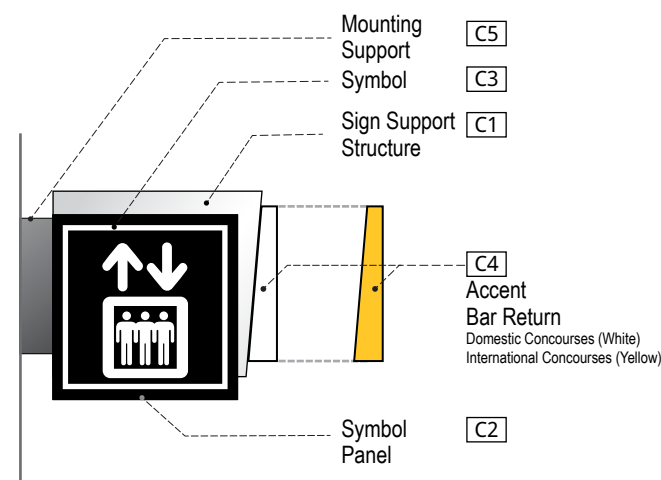

5 SIGN FINISHES
SCALE: NTS

2.3 Sign Type Layouts

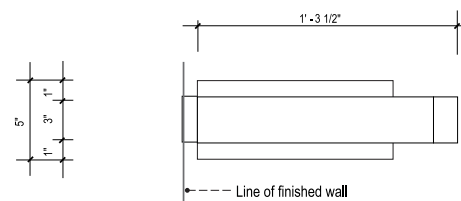

1 TOP VIEW
SCALE: 1-1/2" = 1' - 0"

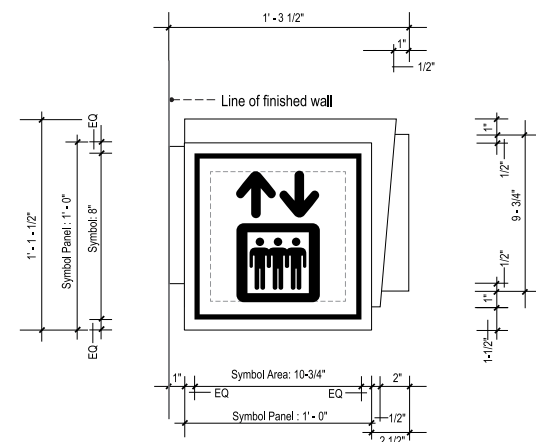

2 FRONT VIEW - RESTROOMS
SCALE: 1-1/2" = 1' - 0"

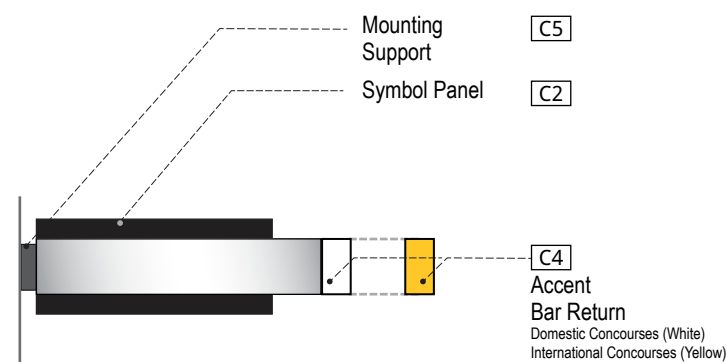

6 TOP VIEW
SCALE: 1-1/2" = 1' - 0"

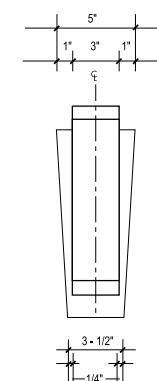

3 SIDE VIEW
SCALE: 1-1/2" = 1' - 0"

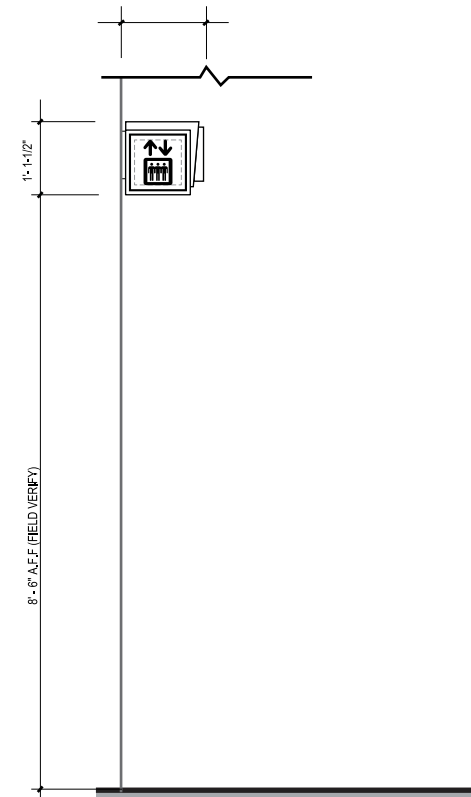

7 ELEVATION
SCALE: 1-1/2" = 1' - 0"

Identification ST-350

- Descriptions:** Secondary Identification
- Dimensions:** 1'- 1-1/2" High x 1' - 3-1/2" Wide x 5" Deep
- Location:** Transportation Malls. Primary circulation corridors - perpendicular to the main pedestrian traffic flow.
- Material:** Seamless fabricated aluminum sign panel with removable symbol panels.
- Lettering:** N/A
- Symbology:** Refer to Section 1 - Graphics Standards
- Colors:**
- [C1] Sign Support Structure - Seamless fabricated .040 thick satin brushed aluminum
 - [C2] Symbol Panel - .125" thick seamless fabricated clear acrylic overlaid with opaque Black vinyl - Internally illuminated
 - [C3] Symbol - Internally illuminated (White)
 - [C4] Accent Bars - 125" seamless bent acrylic with top and bottom caps. LED Internally illuminated. Accent Bar colors : Domestic Concourses - White Acrylic International Concourses - Pantone 123 (Yellow) - Locations T.B.D.: Assigned by Owner / Owner's Rep.
 - [C5] Mounting Support - .125" thick wall mounted channel bracket to receive sign panel, mechanically fastened at installation.
- Graphics:** N/A
- Mounting:** Flag Mounted
- Illuminations:** Internal
- Remarks:**

Note:
1. Colors are not interchangeable, and cannot be substituted.

2.0 SIGN TYPES

#	REVISION	DATE
1	Updated	05/06/16
2	Updated	09/19/17

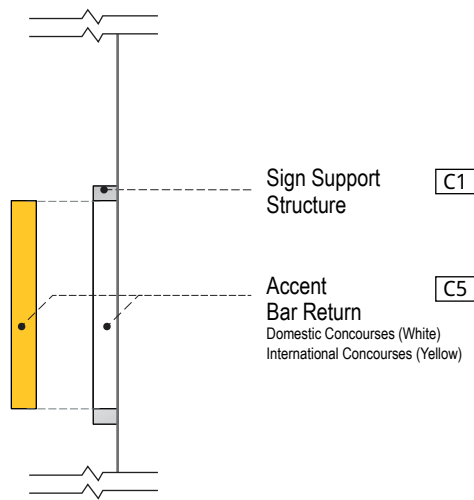

5 SIGN FINISHES
SCALE: NTS

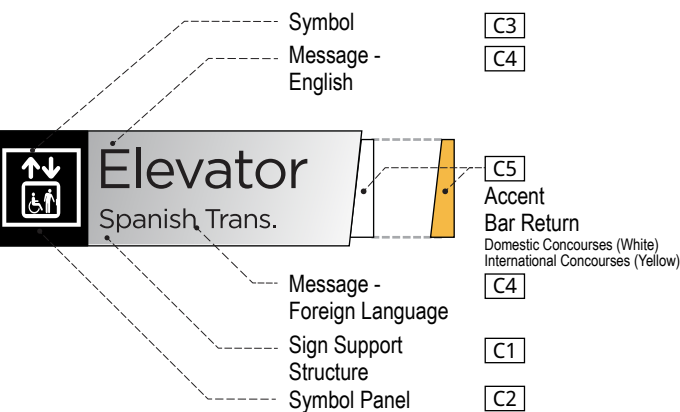

6 SIGN FINISHES
SCALE: NTS

2.3 Sign Type Layouts

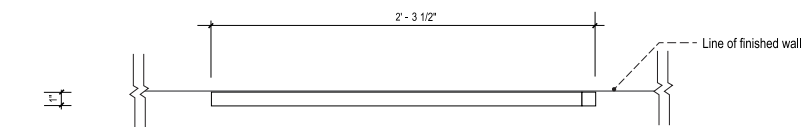

1 TOP VIEW
SCALE: 1 - 1/2" = 1' - 0"

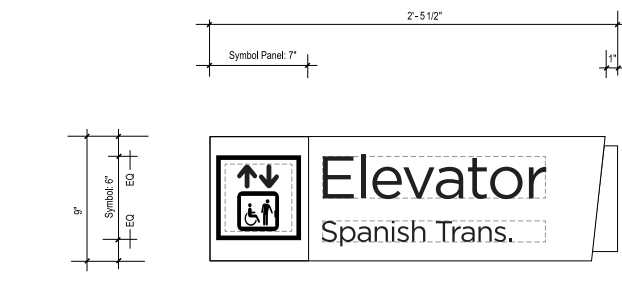

2 FRONT VIEW
SCALE: 1 - 1/2" = 1' - 0"

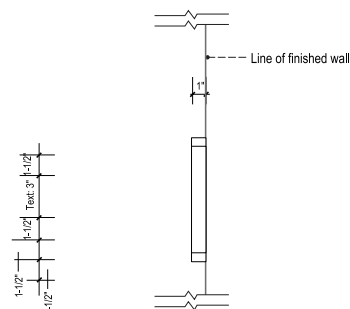

3 SIDE VIEW
SCALE: 1-1/2" = 1' - 0"

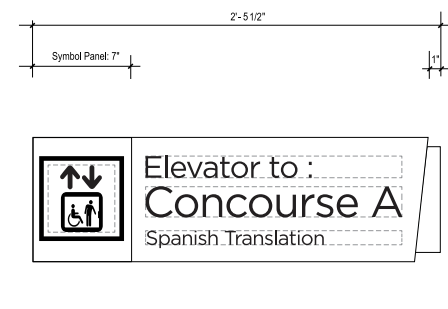

4 FRONT VIEW (ALT. LAYOUT)
SCALE: 1 - 1/2" = 1' - 0"

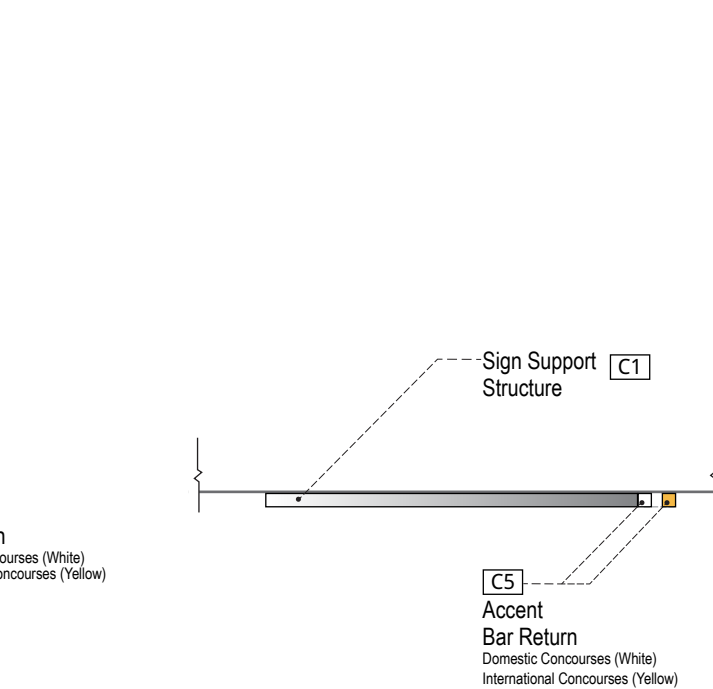

8 TOP VIEW
SCALE: NTS

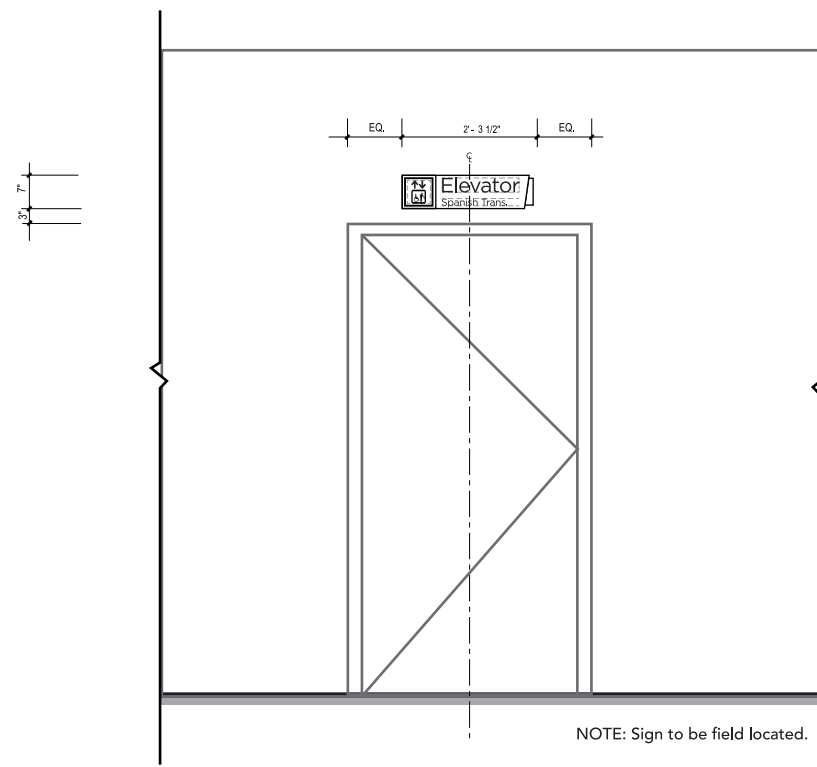

9 ELEVATION
SCALE: 1/2" = 1' - 0"

Identification ST-352

Descriptions: Secondary Identification

Dimensions: 9" High x 2' - 5-1/2" Wide x 1" Deep

Location: Transportation Malls. Identification for Elevators facilities.

Material: Seamless fabricated aluminum sign panel

Lettering: 1. English - Gotham Book - 3" Cap height

Symbology: Refer to Section 1 - Graphics Standards

Colors:

- C1** • Sign Support Structure
- Seamless fabricated .040 thick satin brushed aluminum
- C2** • Symbol Panel
- BLACK VINYL
- C3** • Symbol
- WHITE VINYL
- C4** • Messages - English
- BLACK VINYL
- C5** • Accent Bar
125" seamless bent acrylic with top and bottom caps. LED Internally illuminated. Accent Bar colors :
Domestic Concourses - White Acrylic
International Concourses - Pantone 123 (Yellow) - Locations T.B.D.: Assigned by Owner / Owner's Rep.

Graphics: N/A

Mounting: Wall Mounted

Illuminations: None

Remarks:

Note:
1. Colors are not interchangeable, and cannot be substituted.

2.0 SIGN TYPES

#	REVISION	DATE
1	Updated	05/06/16
2	Updated	09/19/17

2.3 Sign Type Layouts

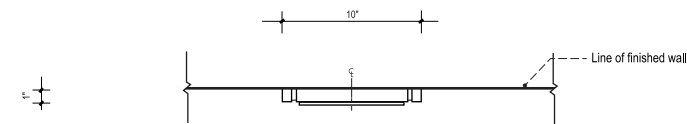

1 TOP VIEW
SCALE: 1 - 1/2" = 1' - 0"

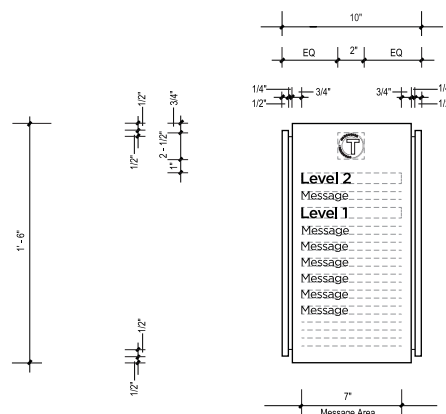

2 FRONT VIEW
SCALE: 1 - 1/2" = 1' - 0"

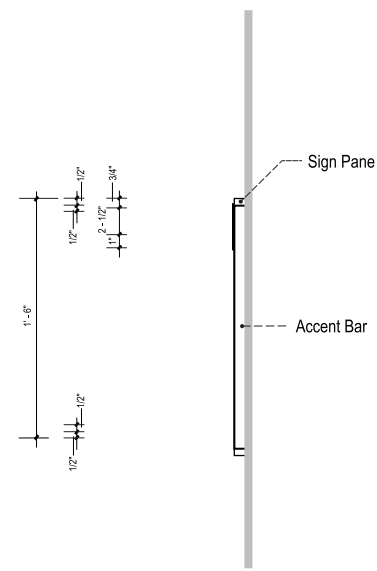

3 SIDE VIEW
SCALE: 1 - 1/2" = 1' - 0"

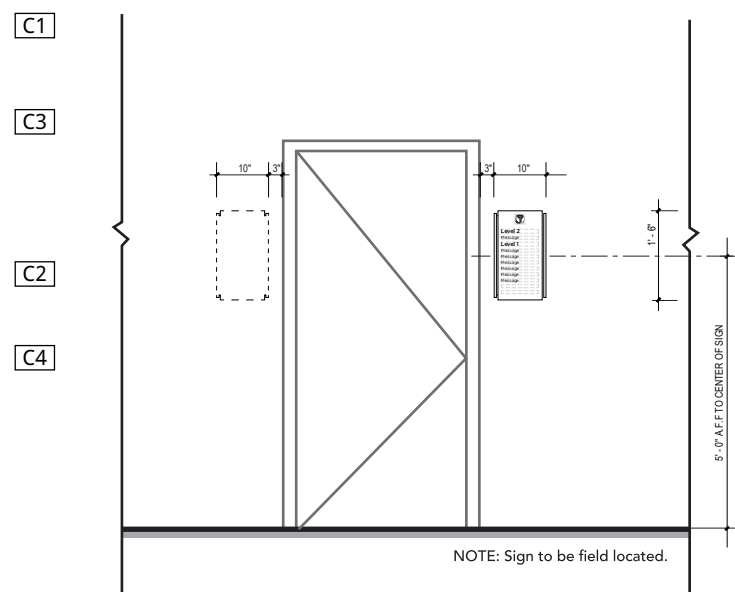
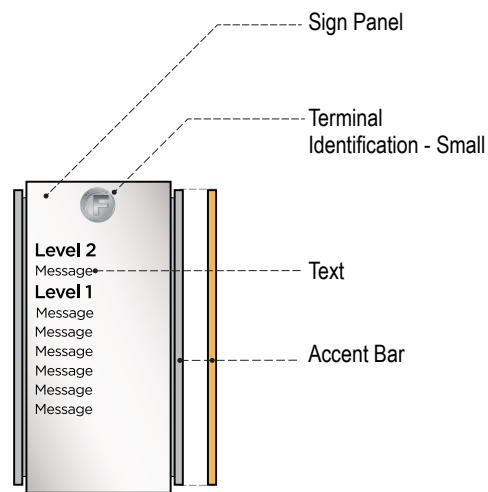

5 ELEVATION - SINGLE ELEVATOR
SCALE: 1/2" = 1' - 0"

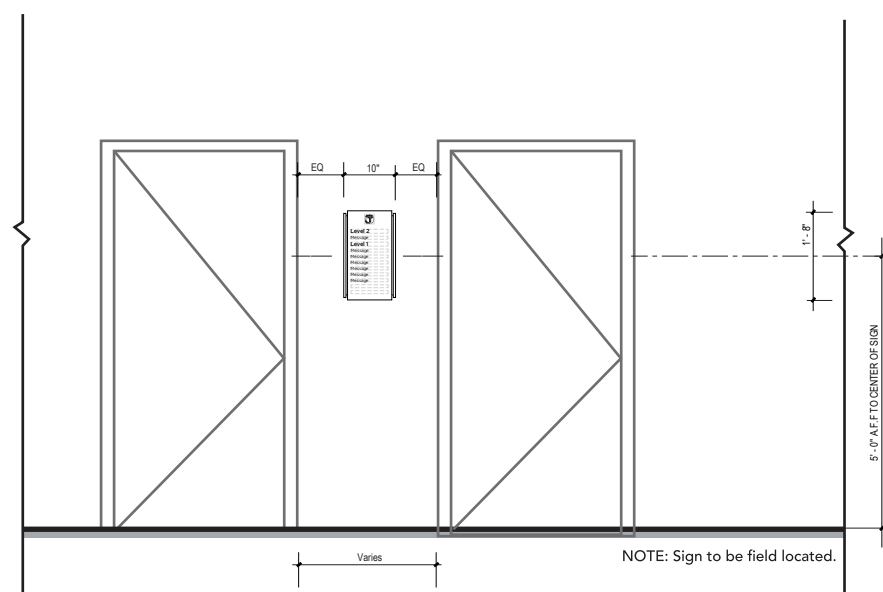

6 ELEVATION - DOUBLE ELEVATORS
SCALE: 1/2" = 1' - 0"

4 SIGN FINISHES
SCALE: 1 - 1/2" = 1' - 0"

Informational ST-360

- Descriptions:** Primary Informational
- Dimensions:** 1'- 6" High x 10" Wide x 1" Deep
- Location:** Transportation Malls Elevators
- Material:** Seamless fabricated clear acrylic laminated with satin brushed aluminum.
- Lettering:** 1. English - Gotham Book - 1/2" Cap height
- Symbology:** Refer to Section 1 - Graphics Standards
- Colors:**
 - C1** • Sign Panel
 - Seamless fabricated .125" clear acrylic with all edges and return sanded to a smooth finish laminated with satin brushed aluminum finish.
 - C2** • Text
 - Machine cut letters applied on first surface Black vinyl.
 - C3** • Refer to Section 1 - Graphics Standards
 - Concourse Identification
 - High resolution digital print mounted onto .125" circular satin brushed finish aluminum.
 - C4** • Accent Bar
 - 125" seamless bent acrylic with top and bottom caps. LED Internally illuminated.
 - Accent Bar colors :
 - Domestic Concourses - White Acrylic
 - International Concourses - Pantone 123 (Yellow) - Locations T.B.D.: Assigned by Owner / Owner's Rep.

Graphics: N/A
Mounting: Wall Mounted
Illuminations: None
Remarks:



 **Hartsfield-Jackson**
Atlanta International Airport.

Prepared by:  **AIS** |  **VALANCOURT**
INTERNATIONAL, LLC